



ALLESTIMENTI VEICOLI COMMERCIALI  
AMÉNAGEMENTS DE VÉHICULES UTILITAIRES



## PEUGEOT BOXER



INNOVATION  
SINCE 1929.



Store Van è l'unico produttore al mondo di allestimenti per veicoli commerciali ad utilizzare questa tecnologia.

StoreVan est le seul fabricant d'aménagements de véhicules utilitaires au monde à utiliser cette technologie.

## TECNOLOGIE

### ACCIAIO GALVANNEALED

La lamiera galvannealed è una variante della lamiera zincata a caldo. Il prodotto subisce un processo di zincatura a caldo e un successivo riscaldamento ad una temperatura di ca. 550°C attraverso il quale lo zinco si salda alla superficie della lamiera formando una lega con l'acciaio.

Il risultato che si ottiene è uno strato zincato uniforme e dalla struttura cristallina fine abbinati ad una **qualità della superficie e una resistenza alla corrosione nettamente superiori**. Questo processo è ideale per le applicazioni automotive. Store Van ha introdotto e implementato tale tecnologia anche nel settore dell'allestimento veicoli industriali.

### VERNICIATURA PER IMMERSIONE - CATODICA - CON RESINA ACRILICA

La verniciatura per cataforesi è un trattamento superficiale di verniciatura in grado di conferire agli elementi dell'allestimento una **notevole resistenza alla corrosione**; è caratterizzata dal **deposito uniforme** di una resina acrilica sulla superficie dell'elemento, assicurando per lungo tempo un'elevata protezione nei confronti degli agenti chimici e di altri tipi di attacchi. La resina acrilica consente una diretta esposizione agli agenti atmosferici mantenendo inalterate le caratteristiche tecniche. Con questo processo si assicura una maggiore protezione dalla ruggine.

- Resistenza alla corrosione superiore a 500 ore (umidità ASTM D1735)
- Eccellente durezza con valutazione minima 2H



#### STORE VAN ORANGE PLANET

Sostenibilità ambientale e sviluppo eco-compatibile sono temi di rilevante attualità ed interesse, sorti dalla crescente consapevolezza che si debba prestare attenzione all'equilibrio ambientale.

#### STORE VAN ORANGE PLANET

La durabilité environnementale et le développement éco-compatibile sont des sujets importants d'actualité et d'intérêt, découlés d'une prise de conscience croissante qu'on doit prêter attention à l'équilibre environnemental.

## TECHNOLOGIES

### ACIER GALVANNEALED

La tôle galvannealed est une variante de la tôle galvanisée à chaud. Le produit est soumis à un procédé de galvanisation à chaud, puis de chauffage à une température d'env. 550 °C par lequel le zinc se soude à la surface de la tôle en formant un alliage avec l'acier.

Le résultat obtenu est une couche de zinc uniforme et une structure cristalline fine combinées à **une qualité de la surface et une résistance à la corrosion nettement plus élevées**. Ce procédé est idéal pour les applications au sein du secteur automobile. StoreVan a introduit et optimisé cette technologie également dans le domaine des aménagements de véhicules utilitaires.

### PEINTURE PAR IMMERSION - CATHODIQUE - AVEC RESINE ACRYLIQUE

La peinture cathodique est un traitement de surface qui permet de conférer aux éléments de l'aménagement **une résistance remarquable à la corrosion** ; elle est caractérisée par le **dépôt uniforme** d'une résine acrylique sur la surface de l'élément, en garantissant une haute et durable protection contre les agents chimiques et d'autres types d'agressions. La résine acrylique permet une exposition directe aux agents atmosphériques, tout en conservant inchangées les caractéristiques techniques. Ce procédé garantit aussi une meilleure protection contre la rouille.

- Résistance à la corrosion supérieure à 500 heures (humidité ASTM D1735)
- Excellente dureté avec une évaluation minimale 2H



# FISSAGGIO FLESSIBILE FIXATION FLEXIBLE

## FLESSIBILITÀ E DUREVOLEZZA DEGLI ALLESTIMENTI PER FURGONI STORE VAN

Store Van utilizza uno speciale sistema a binario per il fissaggio delle scaffalature per furgoni allo chassis del veicolo commerciale, conferendo una grande flessibilità al posizionamento dei moduli e massimizzando l'utilizzo degli spazi interni al furgone attrezzato.

Il sistema prevede l'utilizzo di staffe che scorrono all'interno del binario in tutta la sua lunghezza anziché esser rivettate direttamente ai rinforzi dello chassis, che obbligano, nella progettazione dell'allestimento furgone, a una sostanziale rigidità nella gestione degli spazi. Il binario usato da Store Van viene fissato ai montanti verticali dell'officina mobile, con la doppia funzione di collegare in maniera uniforme gli scaffali per furgoni al telaio del veicolo e di distribuire omogeneamente tutte le forze dinamiche a cui l'allestimento viene sottoposto durante la guida.

Le staffe di fissaggio che collegano il binario al modulo presentano uno speciale snodo che ammortizza le vibrazioni derivanti dalla guida del veicolo, adattandosi ai movimenti torsionali dello chassis, specialmente in percorrenza di curve.

Grazie a questo sistema, i nostri allestimenti per furgoni possono esser progettati con la massima libertà, garantendo comunque alti standard di sicurezza, stabilità e durevolezza nel tempo.

Tutti i nostri sistemi di fissaggio si possono avvalere di sistemi di aggancio/sgancio rapido dei moduli tramite maniglie a ripresa che permettono di smontare l'allestimento senza l'ausilio di utensili. In questo modo la scaffalatura della tua officina mobile può essere dichiarata come materiale trasportato o come ausilio alla sicurezza del carico non permanentemente fissato al veicolo, come descritto nella DIRETTIVA 2014/47 UE, CAPO 1, Articolo 3, paragrafo 5.

## FLEXIBILITÉ ET DURÉE DES AMÉNAGEMENTS POUR FOURGONS STORE VAN

Store Van utilise un système à rail spécial pour la fixation des rayonnages pour fourgons au châssis du véhicule utilitaire : cela garantit une grande flexibilité pour le positionnement des modules et optimise l'utilisation des espaces à l'intérieur du fourgon aménagé.

Le système prévoit l'utilisation d'étriers qui coulissent à l'intérieur du rail sur toute sa longueur au lieu d'être rivetés directement aux renforts du châssis, ce qui impose, dans la conception de l'aménagement du fourgon, une grande rigueur dans la gestion des espaces. Le rail utilisé par Store Van, fixé aux montants verticaux de l'atelier mobile, a une double fonction : solidariser de manière uniforme les rayonnages pour fourgons au châssis du véhicule et distribuer de manière homogène toutes les forces dynamiques auxquelles l'aménagement est soumis durant les déplacements.

Les étriers de fixation qui relient le rail au module présentent un dispositif articulé spécial qui amortit les vibrations causées par le déplacement du véhicule, en s'adaptant aux mouvements de torsion du châssis, en particulier dans les virages.

Grâce à ce système, nos aménagements pour fourgons peuvent être conçus avec la plus grande liberté, mais dans le respect de standards de sécurité, de stabilité et de durée élevés.

Tous nos systèmes de fixation peuvent bénéficier de systèmes d'accrochage/déaccrochage rapide des modules au moyen de poignées de serrage à cliquet qui permettent de démonter l'aménagement sans utiliser d'outils. Le rayonnage de votre atelier mobile peut ainsi être déclaré comme matériel transporté ou comme dispositif de sécurité du chargement fixé au véhicule de manière non permanente, conformément aux dispositions de la directive 2014/47 UE, chapitre 1, article 3, paragraphe 5.



# CERTIFICAZIONI CERTIFICATIONS

## PRODUZIONE CERTIFICATA

- Certificati ISO 9001:2015.
- Superata brillantemente la prova di CRASH TEST eseguita secondo le ultime normative europee ECE-R17 con impatto a 50 Km/h.
- Certificazione GS per l'arredo interno e le rampe di carico.
- Certificazione GS per il portatutto-portascale.

## PRODUCTION CERTIFIÉE

- Certifiés ISO 9001:2015.
- ESSAI DE CHOC réalisé selon les normes européennes ECE-R17 les plus récentes avec impact à 50 km/h, passé brillamment.
- Certification GS pour l'aménagement interne et les rampes de chargement.
- Certification GS pour les galeries de toit et porte-échelles.

**CRASH TEST**  
ECE-R17



## La base per la protezione sicura dei veicoli

La base pour la protection des véhicules en toute sécurité



## SICUREZZA DEL CARICO PER FURGONI E BLOCCAGGIO MERCE

Con il recepimento della direttiva 2014/47/EU verranno intensificati i controlli sui veicoli trasporto merci N2 e N3 e sensibilizzato il controllo del fissaggio del carico. La Direttiva consente agli Stati membri la possibilità di sottoporre a controlli tecnici veicoli che esulano dal suo ambito d'applicazione, come i veicoli commerciali della categoria N 1 e di controllare altri aspetti del trasporto e della sicurezza stradale.

### SISTEMA DI PROTEZIONE DEL VANO DI CARICO E FISSAGGIO DEL CARICO

Il nuovo sistema di protezione integrato per furgoni ideato da Store Van segue le linee guida della nuova direttiva 2014/47/EU e consente il **fissaggio flessibile e sicuro** del carico ai pianali e alle pareti del veicolo.

Con l'impiego dei componenti di aggancio "Airline", e l'integrazione di numerosi accessori come cinghie, reti e pali telescopici, l'utilizzatore del veicolo può configurare la sua piattaforma di aggancio semplice, economica e a norma con la direttiva europea.

Il sistema prevede l'utilizzo di:

- pianali per furgoni in multistrato resina fenolica con predisposizione per gli ancoraggi originali del veicolo e ancoraggi supplementari (pag. 10) a filo pianale con trazione pari a 200 daN;
- barre in alluminio "Airline" ancorate allo châssis (pag. 11);
- pannellature in polipropilene ad alta flessibilità e resistenza per proteggere internamente la carrozzeria dagli urti accidentali (pag.8).

### CON L'APPLICAZIONE DEL NUOVO KIT DI PROTEZIONE, SI PUÒ APPREZZARE UNA LUNGA SERIE DI VANTAGGI:

- l'utilizzatore del veicolo può già fissare il carico in sicurezza alle barre "Airline" tramite le cinghie di trattenuta.
- Il kit di fissaggio integrato prolunga la conservazione del buono stato della carrozzeria.
- Il sistema di protezione conferisce un valore aggiunto, qualità molto importante per il mercato del nuovo e fondamentale per quello dell'usato, solitamente compromesso da danneggiamenti.

## SÉCURITÉ DU CHARGEMENT POUR LES FOURGONS ET BLOCAGE DE LA MARCHANDISE

Suite à la transposition de la directive 2014/47/EU, les contrôles sur les véhicules de transport de marchandises N2 et N3 s'intensifieront et le contrôle de la fixation du chargement fera l'objet d'une attention accrue. La directive offre aux États membres la possibilité de soumettre à des contrôles techniques les véhicules qui échappent à son champ d'application, comme les véhicules utilitaires de la catégorie N 1, et de contrôler d'autres aspects du transport et de la sécurité routière.

### SYSTÈME DE PROTECTION DE L'ESPACE DE CHARGEMENT ET DE FIXATION DU CHARGEMENT

Le nouveau système de protection intégré pour fourgons conçu par Store Van respecte les lignes directrices de la nouvelle directive 2014/47/EU et garantit une **fixation flexible et sûre** du chargement aux planchers et aux parois du véhicule.

En utilisant les composants d'accrochage « Airline » et grâce à l'adoption de nombreux accessoires tels que des sangles, des filets et des barres télescopiques, l'utilisateur du véhicule peut aménager sa plateforme d'accrochage de manière simple, économique et conforme à la directive européenne.

Le système prévoit l'utilisation:

- de planchers pour fourgons en multiplis avec résine phénolique prééquipés pour les arrimages d'origine du véhicule et les arrimages supplémentaires (page 10) au ras du plancher avec une traction de 200 daN ;
- de barres en aluminium « Airline » fixées au châssis (page 11) ;
- de panneaux en polypropylène très flexibles et résistants pour protéger l'intérieur de la carrosserie contre les chocs accidentels (page 8).

### L'APPLICATION DU NOUVEAU KIT DE PROTECTION GARANTIT TOUTE UNE SÉRIE D'AVANTAGES:

- l'utilisateur du véhicule peut déjà fixer, de manière sûre, le chargement aux barres « Airline », grâce aux sangles d'arrimage;
- le kit de fixation intégré permet de conserver la carrosserie en bon état plus longtemps ;
- le système de protection confère au véhicule de la valeur ajoutée, une qualité très importante sur le marché du neuf et fondamentale pour celui de l'occasion, généralement mis à mal par les fréquents dommages.

SAFETY CROSS: punti di fissaggio longitudinali e trasversali su richiesta  
SAFETY CROSS: points de fixation longitudinaux et transversaux sur demande

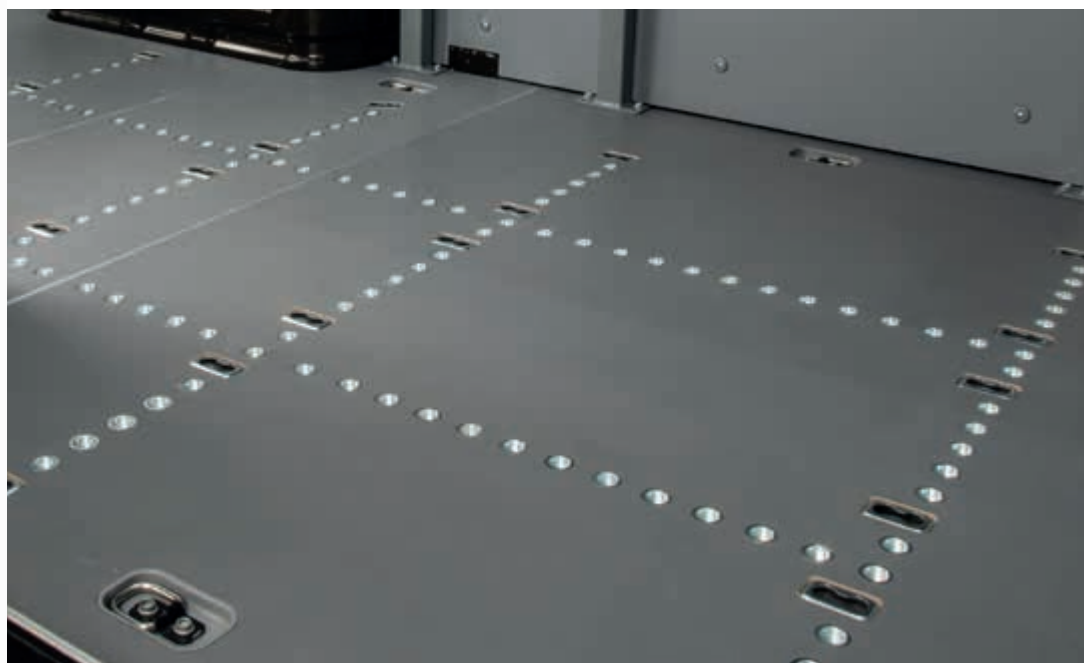



- Pannellature per veicolo con porta laterale destra e pareti lamierate.
- Habillages pour véhicule avec porte latérale droite et parois en tôle.

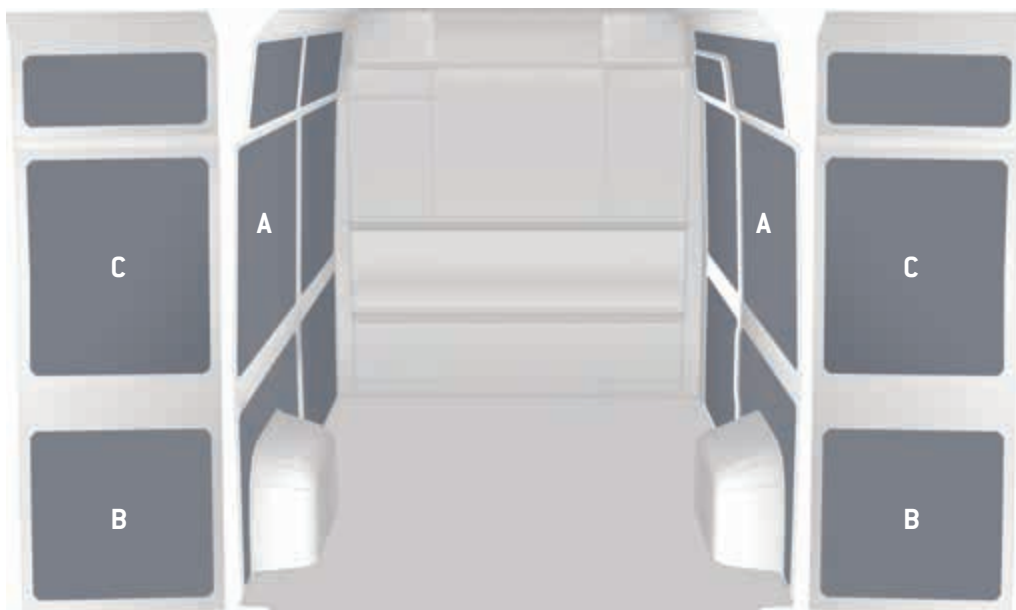

**HONEYCOMB PANEL - A**

- Pannellatura in polipropilene per:
  - parete laterale sinistra
  - parete laterale destra e porta scorrevole
- Habillage en polypropylène pour:
  - paroi latérale gauche
  - paroi latérale droite et porte coulissante

**HONEYCOMB PANEL - B**

- Pannellatura in polipropilene per:
  - parte inferiore delle porte posteriori a battente
- Habillage en polypropylène pour:
  - partie inférieure des portes arrière battantes

**HONEYCOMB PANEL - C**

- Pannellatura in polipropilene per:
  - parte superiore delle porte posteriori a battente
- Habillage en polypropylène pour:
  - partie supérieure des portes arrière battantes

VEICOLO VÉHICULE	PANNELLATURA HABILLAGE	
	A+B	C
	ART.	ART.
Modello - Modèle L1 H1	<b>F22 HP DU10H1 A0 01</b> 12,47 kg	<b>F22 HP DUDRH1 A0 01</b> 2,03 kg
Modello - Modèle L1 H2	<b>F22 HP DU10H2 A0 01</b> 15,16 kg	<b>F22 HP DUDRH2 A0 01</b> 2,69 kg
Modello - Modèle L2 H1	<b>F22 HP DU20H1 A0 01</b> 15,60 kg	<b>F22 HP DUDRH1 A0 01</b> 2,03 kg
Modello - Modèle L2 H2	<b>F22 HP DU20H2 A0 01</b> 18,14 kg	<b>F22 HP DUDRH2 A0 01</b> 2,69 kg
Modello - Modèle L3 H2	<b>F22 HP DU30H2 A0 01</b> 22,13 kg	<b>F22 HP DUDRH2 A0 01</b> 2,69 kg
Modello - Modèle L3 H3	<b>F22 HP DU30H3 A0 01</b> 25,18 kg	<b>F22 HP DUDRH3 A0 01</b> 3,25 kg
Modello - Modèle L4 H2	<b>F22 HP DU3LH2 A0 01</b> 25,98 kg	<b>F22 HP DUDRH2 A0 01</b> 2,69 kg
Modello - Modèle L4 H3	<b>F22 HP DU3LH3 A0 01</b> 29,96 kg	<b>F22 HP DUDRH3 A0 01</b> 3,25 kg





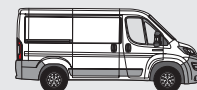

- Pianale per veicolo con porta laterale destra e pareti lamierate.
- Plancher pour véhicule avec porte latérale droite et parois en tôle.



**WOOD FLOOR - D**

- Pianale in legno spessore 9/12 mm con rivestimento fenolico e predisposizione per gli ancoraggi originali del veicolo
- Plancher en bois de 9/12 mm avec revêtement phénolique et équipé pour les ancrages originaux du véhicule

**WOOD FLOOR - F**

- Pannello retrocabina in legno spessore 12 mm con rivestimento fenolico
- Panneau arrière cabine en bois de 12 mm d'épaisseur avec revêtement phénolique

VEICOLO VÉHICULE	PIANALE 9 mm PLANCHER 9 mm	PIANALE 12 mm PLANCHER 12 mm	RETROCABINA ARRIÈRE CABINE
	D	D	F (1594x820x12 mm)
	ART.	ART.	ART.
Modello - Modèle L1	<b>F22 WF DU10D1 A0 1S</b> 29,99 kg	<b>F22 WF DU10T1 A0 1S</b> 37,43 kg	<b>F22 WF DUWBT1 A0 1S</b> 10,78 kg
Modello - Modèle L2	<b>F22 WF DU20D1 A0 1S</b> 35,80 kg	<b>F22 WF DU20T1 A0 1S</b> 44,59 kg	<b>F22 WF DUWBT1 A0 1S</b> 10,78 kg
Modello - Modèle L3	<b>F22 WF DU30D1 A0 1S</b> 42,81 kg	<b>F22 WF DU30T1 A0 1S</b> 53,39 kg	<b>F22 WF DUWBT1 A0 1S</b> 10,78 kg
Modello - Modèle L4	<b>F22 WF DU3LD1 A0 1S</b> 47,36 kg	<b>F22 WF DU3LT1 A0 1S</b> 59,02 kg	<b>F22 WF DUWBT1 A0 1S</b> 10,78 kg





- Pannellatura per veicolo con porta laterale destra e pareti lamierate.
- Habillages pour véhicule avec porte latérale droite et parois en tôle.

**ALUMINIUM PANEL - A**

- Pannellatura in alluminio per:
  - parete laterale sinistra
  - parete laterale destra e porta scorrevole
- Panneaux en aluminium pour:
  - paroi latérale gauche
  - paroi latérale droite et porte coulissante

**ALUMINIUM PANEL - B**

- Pannellatura in alluminio per:
  - parte inferiore delle porte posteriori a battente
- Panneaux en aluminium pour:
  - partie inférieure des portes arrière battantes

**ALUMINIUM PANEL - C**

- Pannellatura in alluminio per:
  - parte superiore delle porte posteriori a battente
- Panneaux en aluminium pour:
  - partie supérieure des portes arrière battantes

**VEICOLO  
VÉHICULE****PANNELLATURA IN ALLUMINIO  
PANNEAUX EN ALUMINIUM**

	A+B	C
	ART.	ART.
Modello - Modèle L1 H1	<b>F22 AP DU10H1 A0 00</b> 21,57 kg	<b>F22 AP DUDRH1 A0 00</b> 3,48 kg
Modello - Modèle L1 H2	<b>F22 AP DU10H2 A0 00</b> 26,04kg	<b>F22 AP DUDRH2 A0 00</b> 4,62 kg
Modello - Modèle L2 H1	<b>F22 AP DU20H1 A0 00</b> 27,00 kg	<b>F22 AP DUDRH1 A0 00</b> 3,48 kg
Modello - Modèle L2 H2	<b>F22 AP DU20H2 A0 00</b> 31,36 kg	<b>F22 AP DUDRH2 A0 00</b> 4,62 kg
Modello - Modèle L3 H2	<b>F22 AP DU30H2 A0 00</b> 38,24 kg	<b>F22 AP DUDRH2 A0 00</b> 4,62 kg
Modello - Modèle L3 H3	<b>F22 AP DU30H3 A0 00</b> 43,51 kg	<b>F22 AP DUDRH3 A0 00</b> 5,6 kg
Modello - Modèle L4 H2	<b>F22 AP DU3LH2 A0 00</b> 43,89 kg	<b>F22 AP DUDRH2 A0 00</b> 4,62 kg
Modello - Modèle L4 H3	<b>F22 AP DU3LH3 A0 00</b> 50,39 kg	<b>F22 AP DUDRH3 A0 00</b> 5,6 kg

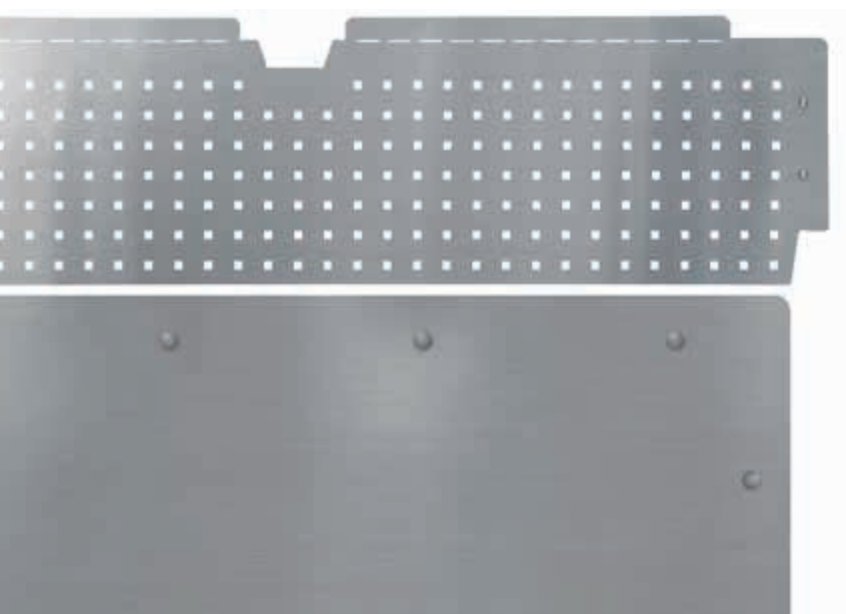
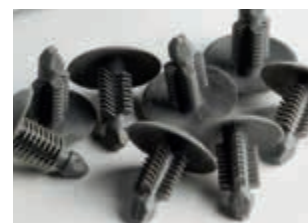

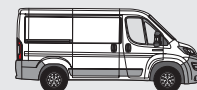

- Pianale per veicolo con porta laterale destra e pareti lamierate.
- Plancher pour véhicule avec porte latérale droite et parois en tôle.



**ALUMINIUM FLOOR - D**

- Pianale in legno spessore 9 mm con rivestimento in alluminio mandrolato da 2 mm e predisposizione per gli ancoraggi originali del veicolo
- Plancher en bois de 9 mm d'épaisseur à revêtement en aluminium larmé de 2 mm, spécifiquement conçu pour s'adapter aux ancrages d'origine du véhicule



VEICOLO VÉHICULE	PIANALE IN ALLUMINIO (Legno + Alluminio ) PLANCHER EN ALUMINIUM (Bois + Aluminium)
	<b>D</b>
	<b>ART.</b>
<b>Modello - Modèle</b> L1	<b>F22 AF DU10B1 A0 00 + F22 AF DU10A1 A0 00</b> 33,92 kg + 28,12kg
<b>Modello - Modèle</b> L2	<b>F22 AF DU20B1 A0 00 + F22 AF DU20A1 A0 00</b> 39,49 kg + 33,32 kg
<b>Modello - Modèle</b> L3	<b>F22 AF DU30B1 A0 00 + F22 AF DU30A1 A0 00</b> 46,52 kg + 40,04 kg
<b>Modello - Modèle</b> L4	<b>F22 AF DU3LB1 A0 00 + F22 AF DU3LA1 A0 00</b> 50,72 kg + 44,39 kg

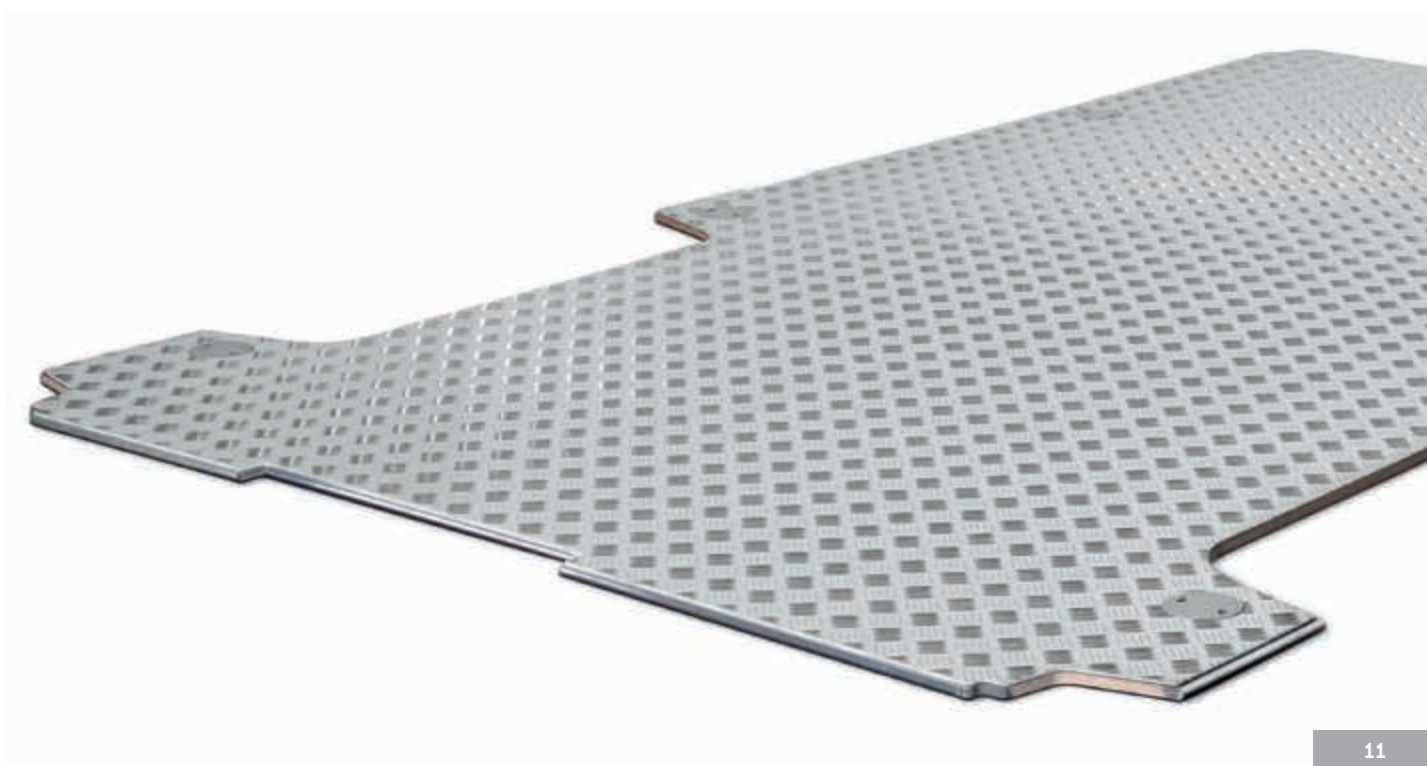
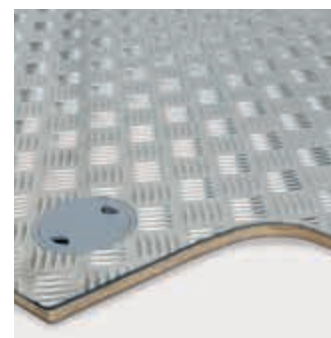



- Pianale per veicolo con porta laterale destra e pareti lamierate.
- Plancher pour véhicule avec porte latérale droite et parois en tôle.

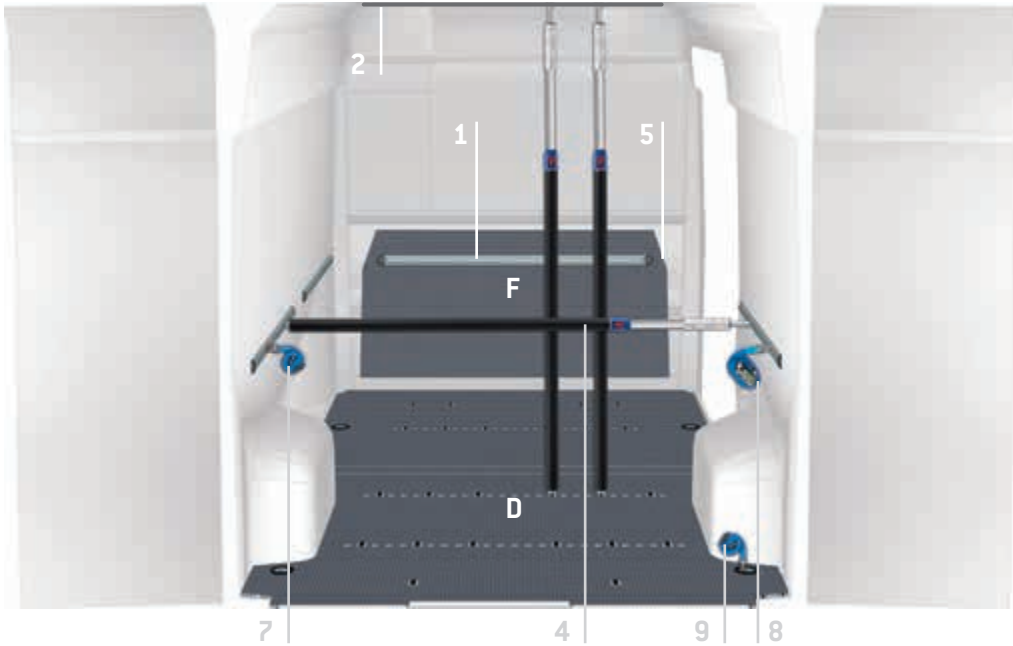

## SAFETY FLOOR - D

- Pianale in legno spessore 9 mm con rivestimento fenolico e sistema di ancoraggio aggiuntivo
- Plancher 9 mm en bois avec revêtement phénolique et points d'ancrage supplémentaires

## WOOD FLOOR - F

- Pannello retrocabina in legno spessore 12 mm con rivestimento fenolico
- Panneau arrière cabine en bois de 12 mm d'épaisseur avec revêtement phénolique

VEICOLO VÉHICULE	PIANALE 9 mm PLANCHER 9 mm	RETROCABINA ARRIÈRE CABINE
	D	F (1594x820x12 mm)
	ART.	ART.
Modello - Modèle L1	F22 SF DU10G1 A0 1S 33,63 kg	F22 WF DUWBT1 A0 1S 10,78 kg
Modello - Modèle L2	F22 SF DU20G1 A0 1S 39,41 kg	F22 WF DUWBT1 A0 1S 10,78 kg
Modello - Modèle L3	F22 SF DU30G1 A0 1S 48,28 kg	F22 WF DUWBT1 A0 1S 10,78 kg
Modello - Modèle L4	F22 SF DU3LG1 A0 1S 53,76 kg	F22 WF DUWBT1 A0 1S 10,78 kg



Il pianale deve essere incollato al veicolo  
Le plancher doit être collé au véhicule

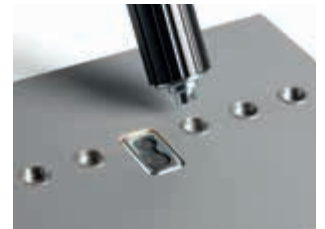

- Colla siliconica per pianali.
- Colle en silicone pour planchers.

ART.

F22 VT V22585 00 08



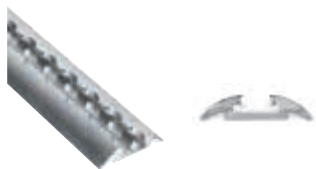
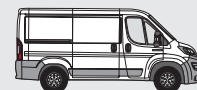

1

- Barra orizzontale in alluminio.
- Barre horizontale en aluminium.

ART. **F22 FC V18029 05 00** L. 500 mm  
**F22 FC V18029 10 00** L. 1000 mm  
**F22 FC V18029 15 00** L. 1500 mm  
**F22 FC V18029 20 00** L. 2000 mm  
**F22 FC V18029 25 00** L. 2500 mm

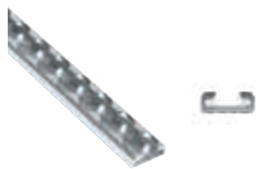

2

- Barra orizzontale in alluminio.
- Barre horizontale en aluminium.

ART. **F22 FC V18025 05 00** L. 500 mm  
**F22 FC V18025 10 00** L. 1000 mm  
**F22 FC V18025 15 00** L. 1500 mm  
**F22 FC V18025 20 00** L. 2000 mm



5

- Finale in plastica per barra serie V18029.
- Bouchon en plastique pour barre série V18029.

ART. **F22 FC V22106 00 00**



10

- Finale in plastica per barra serie V18025.
- Bouchon en plastique pour barre série V18025.

ART. **F22 FC V23389 00 00**

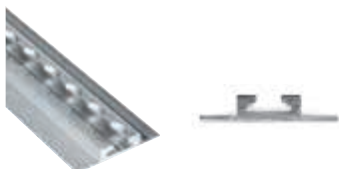

3

- Barra orizzontale in alluminio.
- Barre horizontale en aluminium.

ART. **F22 FC V18030 10 00** L. 1000 mm  
**F22 FC V18030 15 00** L. 1500 mm  
**F22 FC V18030 20 00** L. 2000 mm  
**F22 FC V18030 25 00** L. 2500 mm  
**F22 FC V18030 30 00** L. 3000 mm



4

- Barra telescopica fermacarico.
- Barre télescopique d'arrimage.

ART. **F22 FC V22149 00 00** L. 650-900 mm  
**F22 FC V22734 00 00** L. 850-1100 mm  
**F22 FC V22735 00 00** L. 1050-1300 mm  
**F22 FC V22131 00 00** L. 1250-1750 mm  
**F22 FC V22017 00 00** L. 1550-2050 mm  
**F22 FC V22086 00 00** L. 2000-2500 mm



6

- Anello fermacarico.
- Anneau d'arrimage.

ART. **F22 FC V22582 00 00**



7

- Cinghia fermacarico con morsetto 2500+500.
- Sangle d'arrimage avec crochet 2500+500.

ART. **F22 FC V22136 00 00**



8

- Cinghia fermacarico con cricchetto 2500+500.
- Sangle d'arrimage à cliquet 2500+500.

ART. **F22 FC V22124 00 00**



9

- Cinghia fermacarico con cricchetto 4500+500.
- Sangle d'arrimage à cliquet 4500+500.

ART. **F22 FC V22148 00 00**



- Esempio valigetta per il fissaggio del carico.
- Exemple de mallette pour sécurisation du chargement.



**F22 SB BOX080 00 01**  
**1 ART.**  
 L=440 P=350 H=80 mm



**F22 SB CPV080 00 01**  
**1 ART.**



**F22 SB YELLOW 63 05**  
**1 ART. YELLOW**



**F22 FC V22582 00 00**  
**4 ART.**



**F22 FC V22136 00 00**  
**2 ART.**



**F22 FC V22124 00 00**  
**2 ART.**



**F22 FC V22148 00 00**  
**2 ART.**



# LEGENDA PANNELLATURE - LÉGENDE HABILLAGES

PEUGEOT BOXER  
FURGONE LAMIERATO - FOURGON TÔLÉ

HP  
HONEYCOMB  
PANEL

- Per veicolo con porta laterale destra e pareti lamierate.
- Pour véhicule avec porte latérale droite et parois en tôle.

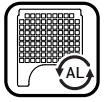

Modello - Modèle  
L1 H1

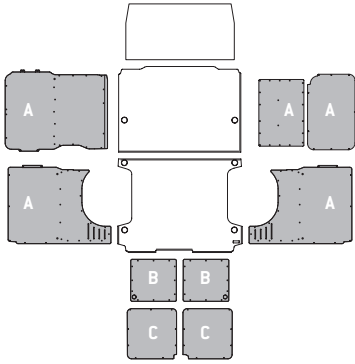

Modello - Modèle  
L1 H2

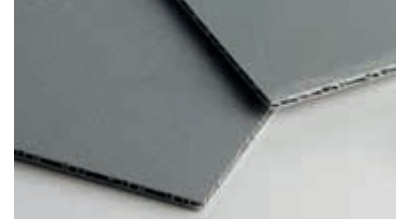
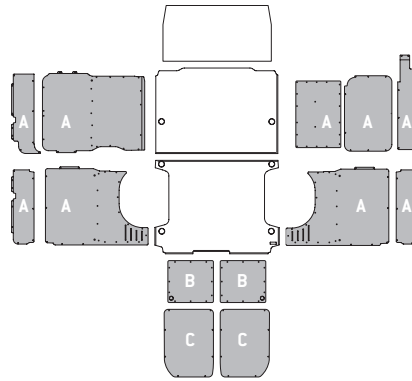

Modello - Modèle  
L2 H1

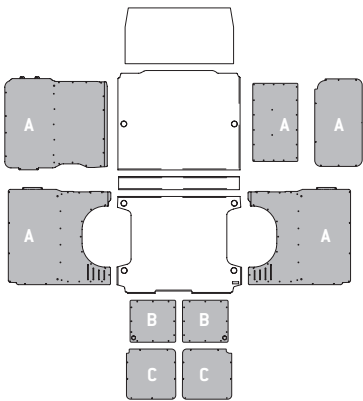

Modello - Modèle  
L2 H2

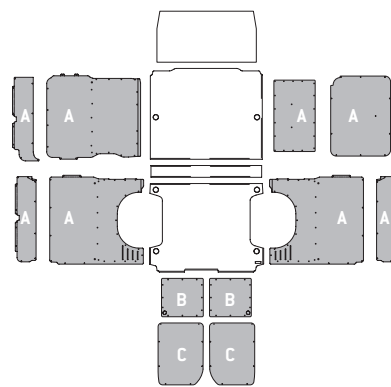

Modello - Modèle  
L3 H2

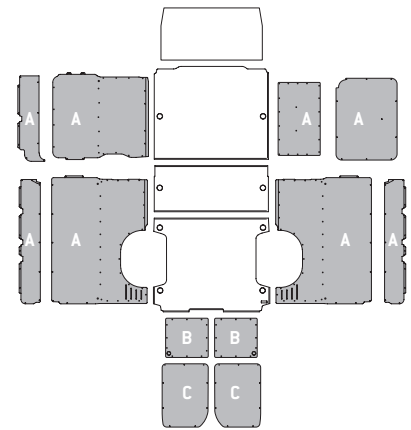

Modello - Modèle  
L3 H3

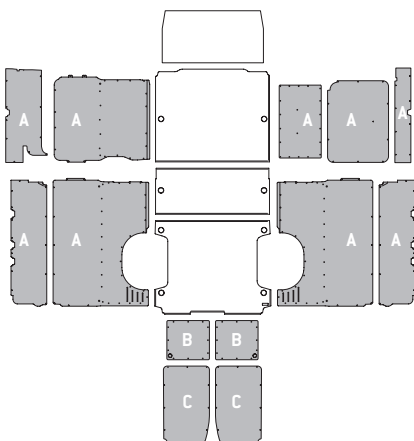

Modello - Modèle  
L4 H2

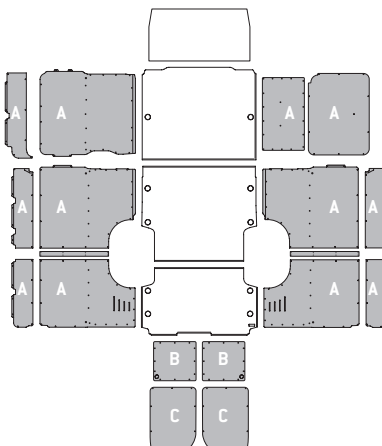

Modello - Modèle  
L4 H3

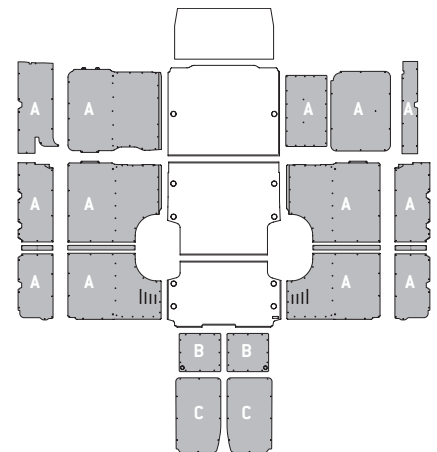



- Per veicolo con porta laterale destra e pareti lamierate.
- Pour véhicule avec porte latérale droite et parois en tôle.

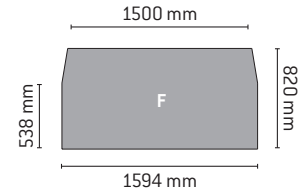
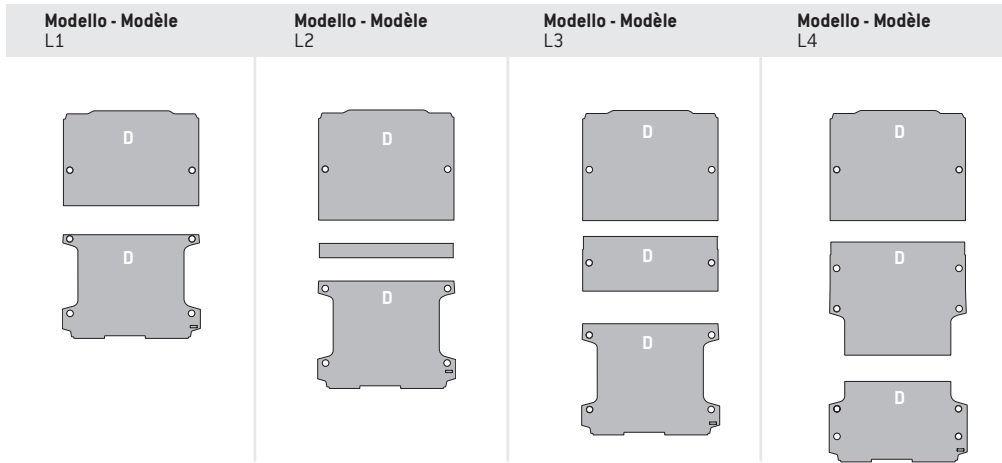

- Pannello retrocabina
- Panneau arrière cabine

FURGONE LAMIERATO - FOURGON TÔLE  
**PEUGEOT BOXER**

WOOD  
FLOOR  
**WF**

- Per veicolo con porta laterale destra e pareti lamierate.
- Pour véhicule avec porte latérale droite et parois en tôle.

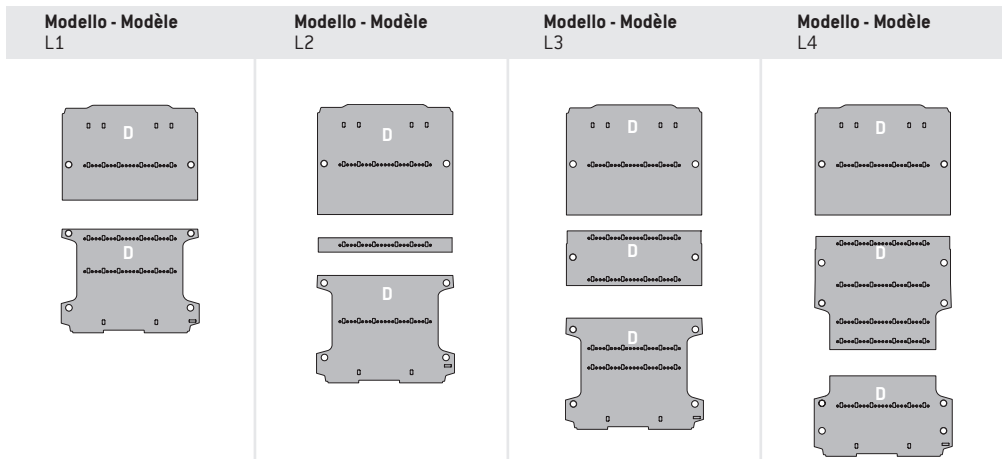

- Per ogni pianale, ogni fila di fissaggi è composta da 6 punti di ancoraggio "Airline" e 19 punti di fissaggio per pali "Airline".
- Sur chaque plancher, chaque rangée d'arrimages se compose de 6 points d'ancrage "Airline" et 19 points de fixation pour barres d'arrimage "Airline".

SAFETY  
FLOOR  
**SF**

- Per veicolo con porta laterale destra e pareti lamierate.
- Pour véhicule avec porte latérale droite et parois en tôle.

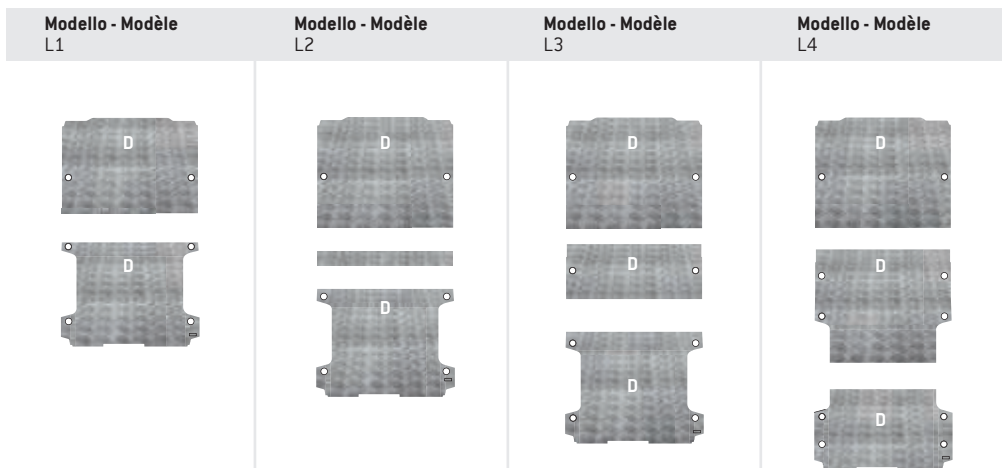

ALUMINIUM  
FLOOR  
**AF**



## SAFETY



**Il fissaggio del carico  
è di serie**

La fixation du  
chargement de série





La soluzione d'**allestimento per furgoni SAFETY** di Store Van nasce per soddisfare i requisiti delle nuove disposizioni sulla sicurezza del carico. Nei moduli vengono integrati elementi strutturali che permettono l'utilizzo di sistemi di trattenuta "Airline", quali cinghie, reti e pali telescopici. Questo nuovo livello di **allestimento per veicoli commerciali** facilita l'ancoraggio di oggetti medio piccoli anche in presenza di pianali per furgoni privi di sistemi di ancoraggio, garantendo così la sicurezza del carico. Gli elementi di ancoraggio "Airline" del livello SAFETY aumentano la stabilità del modulo senza maggiorarne il peso in quanto integrati nella struttura stessa dell'allestimento.

La solution d'**aménagement pour fourgons SAFETY** de Store Van a été conçue pour répondre aux exigences des nouvelles dispositions en matière de sécurité du chargement. Dans les modules, les éléments structurels intégrés permettent d'utiliser des systèmes de maintien « Airline », tels que des sangles, des filets et des barres télescopiques. Ce nouveau niveau d'**aménagement pour véhicules utilitaires** facilite l'arrimage d'objets moyens et petits, même en cas de planchers pour fourgons sans systèmes d'arrimage, ce qui garantit la sécurité du chargement. Les éléments d'arrimage « Airline » du niveau SAFETY améliorent la stabilité du module sans augmenter son poids car ils sont intégrés dans la structure même de l'aménagement.





## PROFESSIONAL

**L'integrazione perfetta  
tra veicolo e allestimento  
officina mobile**

**L'intégration parfaite  
entre le véhicule et  
l'aménagement de  
l'atelier mobile**



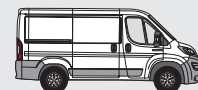

L'allestimento per furgoni PROFESSIONAL progettato da Store Van è integrato perfettamente nel veicolo ed è studiato appositamente per esaltarne le caratteristiche strutturali e dinamiche. I moduli di questo nuovo livello di **allestimento per veicolo commerciale**, come le scaffalature per furgoni, integrano, di serie, elementi per un perfetto fissaggio del carico al telaio del veicolo mediante l'utilizzo dei sistemi di trattenuta "Airline". Sono disponibili sistemi di trattenuta del carico verticali e orizzontali grazie al nuovo pianale SAFETY FLOOR.

L'aménagement pour fourgons PROFESSIONAL conçu par Store Van est parfaitement intégré au véhicule et a été spécialement étudié pour en optimiser les caractéristiques structurelles et dynamiques. Les modules de ce nouveau niveau d'**aménagement pour véhicule utilitaire**, comme les rayonnages pour fourgons, comprennent, de série, des éléments conçus pour une fixation parfaite du chargement au châssis du véhicule grâce à l'utilisation des systèmes de maintien « Airline ». Des systèmes de maintien du chargement verticaux et horizontaux sont disponibles grâce au nouveau plancher SAFETY FLOOR.

FURGONE LAMIERATO - FOURGON TÔLE  
PEUGEOT BOXER

PROFESSIONAL





## MOBILE



**La mobilità  
oltre il veicolo**

**La mobilità  
au-delà du  
véhicule**



La soluzione MOBILE integra gli allestimenti per veicoli commerciali Store Van con le valigette portaminuterie serie STORE BOX 102 – 136 – 238 e il relativo carrellino per facilitare l'utilizzatore dell'**officina mobile** nel trasporto della merce e dell'attrezzatura dal veicolo al luogo di lavoro.

I nuovi elementi di ancoraggio "Airline" aumentano la stabilità del modulo senza influenzarne il peso. Anche in questo caso vengono integrati nella scaffalatura degli elementi che permettono l'uso dei sistemi di trattenuta "Airline". Possono essere scelti sistemi di fissaggio del carico sia verticali che orizzontali grazie anche all'introduzione del pianale SAFETY FLOOR.

La solution MOBILE comprend les aménagements pour véhicules utilitaires Store Van avec les mallettes pour les petits composants série STORE BOX 102 – 136 – 238 et le chariot pour aider l'utilisateur de l'**atelier mobile** dans les opérations de transport de la marchandise et de l'outillage entre le véhicule et le lieu d'intervention.

Les nouveaux éléments d'arrimage « Airline » améliorent la stabilité du module sans augmenter son poids. Dans ce cas également, des éléments intégrés dans le rayonnage permettent l'utilisation des systèmes de maintien « Airline ». Il est également possible de choisir des systèmes de fixation du chargement aussi bien verticaux qu'horizontaux grâce à l'adoption du plancher SAFETY FLOOR.





L1 H1

PEUGEOT BOXER  
FURGONE LAMIERATO - FOURGON TÔLÉ

SAFETY

# L1 H1 SAFETY

ESEMPI DI ALLESTIMENTO - EXEMPLES D'AMÉNAGEMENTS

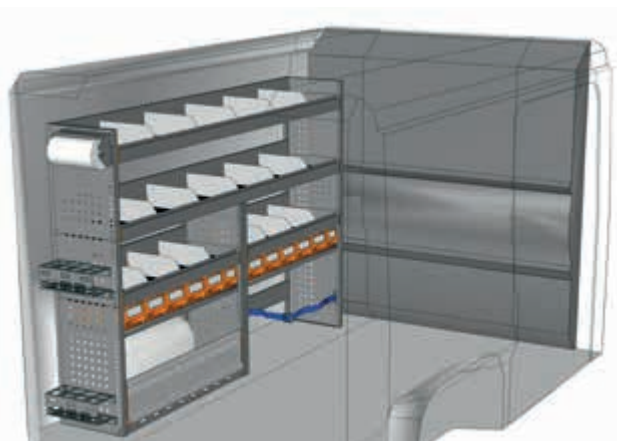

ESEMPIO - EXEMPLE

DU 2014 02\*

L=2032 P=365 H=1400 mm

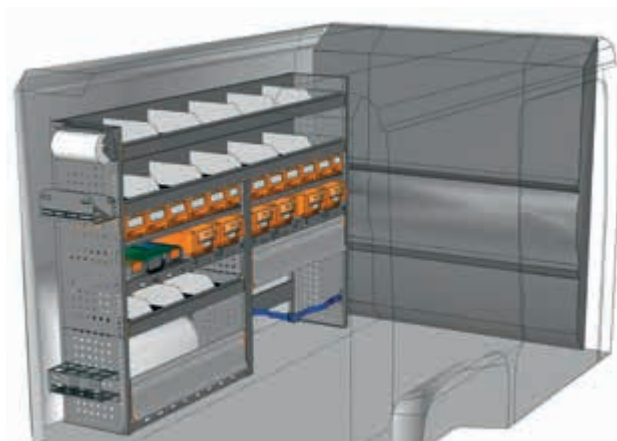
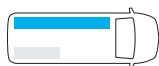

ESEMPIO - EXEMPLE

DU 2014 04\*

L=2032 P=365 H=1400 mm

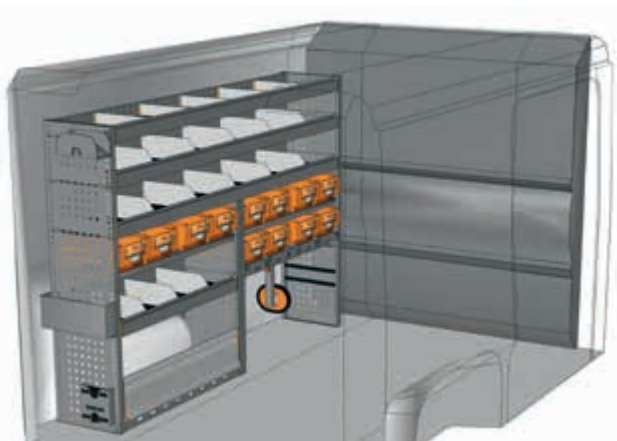
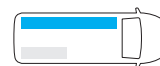

ESEMPIO - EXEMPLE

DU 2014 07\*

L=2032 P=365 H=1400 mm

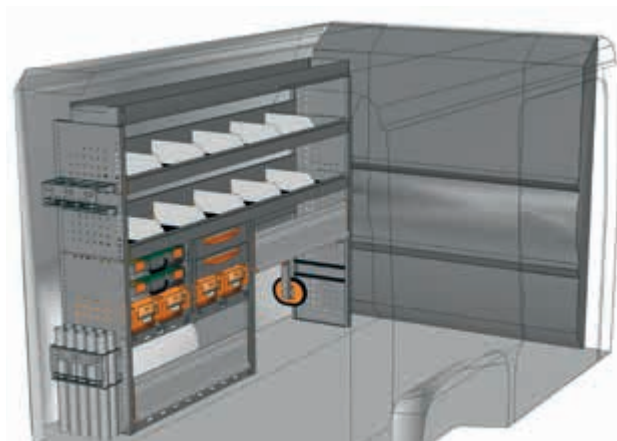

ESEMPIO - EXEMPLE

DU 2015 01\*

L=2032 P=365 H=1490 mm

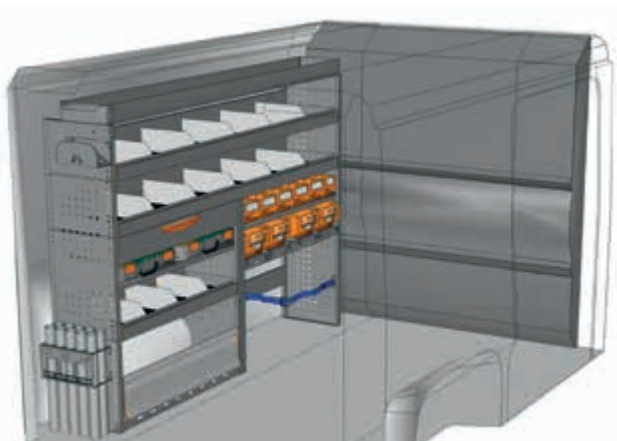

ESEMPIO - EXEMPLE

DU 2015 03\*

L=2032 P=365 H=1490 mm

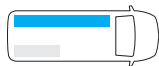

\* Kit fissaggio incluso - Jeu de fixation inclus



ESEMPI DI ALLESTIMENTO - EXEMPLES D'AMÉNAGEMENTS

SAFETY

L1 H1

FURGONE LAMIERATO - FOURGON TÔLE  
PEUGEOT BOXER

SAFETY

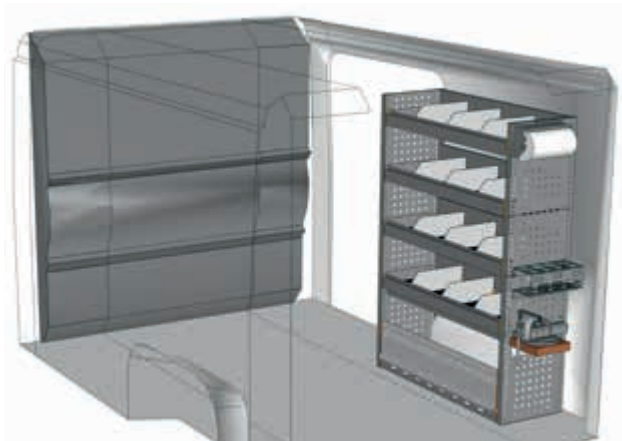

ESEMPIO - EXEMPLE

DU 1014 01\*

L=1016 P=365 H=1400 mm



ESEMPIO - EXEMPLE

DU 1014 02\*

L=1016 P=365 H=1400 mm

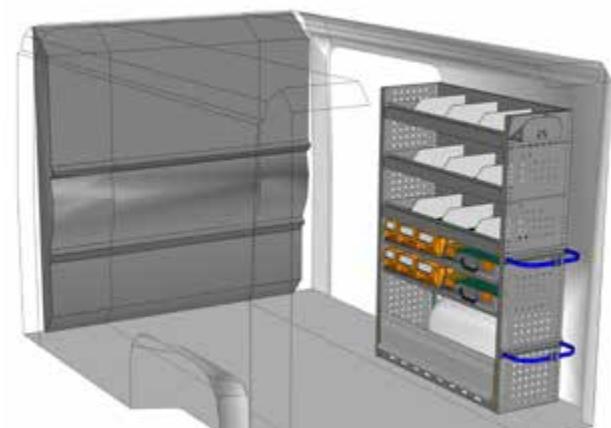

ESEMPIO - EXEMPLE

DU 1014 05\*

L=1016 P=365 H=1400 mm

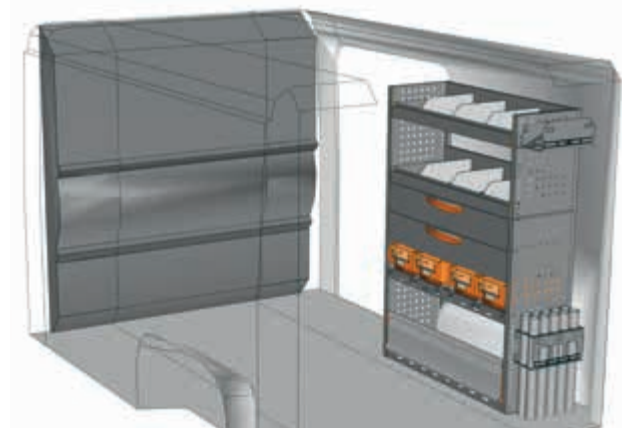
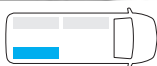

ESEMPIO - EXEMPLE

DU 1014 08\*

L=1016 P=365 H=1400 mm

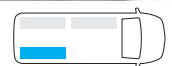

Vista da porta laterale  
Vue de porte latérale



ESEMPIO - EXEMPLE

DU 1014 10\*

L=1016 P=365 H=1400 mm

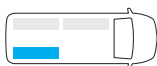

**Non hai trovato il tuo allestimento?**  
**Affidati ai nostri professionisti**  
Guarda il retro di questo catalogo e  
contatta il punto Store Van piu vicino  
oppure visita il nostro sito.

**Vous n'avez pas trouvé votre  
équipement ? Confiez-vous  
à nos professionnels**  
Voir au dos de ce catalogue  
et contactez le point StoreVan  
le plus proche ou visitez notre site web.



\* Kit fissaggio incluso - Jeu de fixation inclus



L1 H1

PEUGEOT BOXER  
FURGONE LAMIERATO - FOURGON TÔLÉ

PROFESSIONAL

# L1 H1 PROFESSIONAL

ESEMPI DI ALLESTIMENTO - EXEMPLES D'AMÉNAGEMENTS

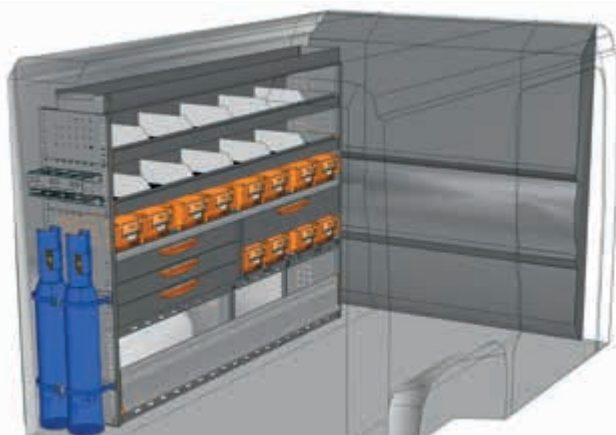

ESEMPIO - EXEMPLE

DU 2015 P1\*

L=2032 P=365 H=1490 mm

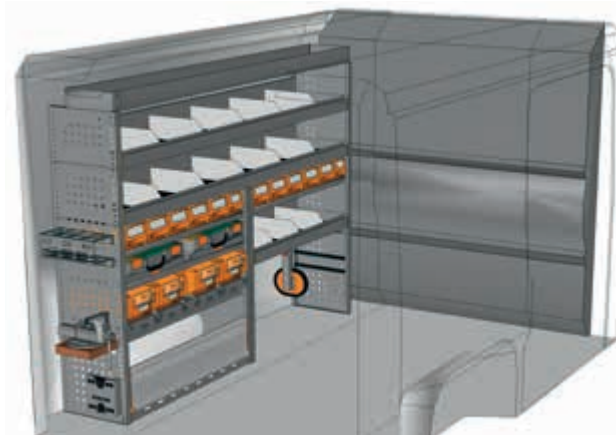
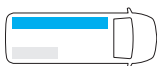

ESEMPIO - EXEMPLE

DU 2015 P2\*

L=2032 P=365 H=1490 mm

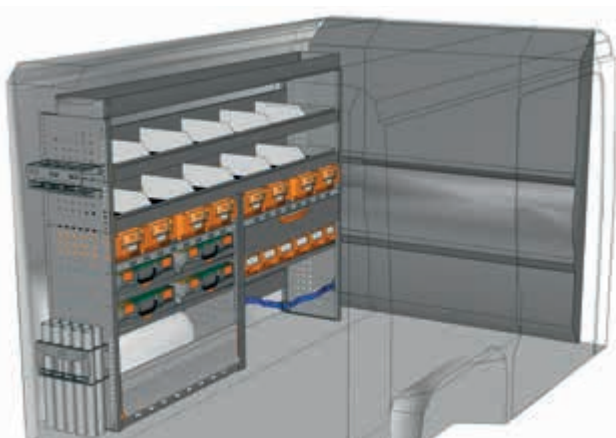
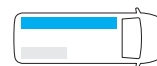

ESEMPIO - EXEMPLE

DU 2015 P3\*

L=2032 P=365 H=1490 mm

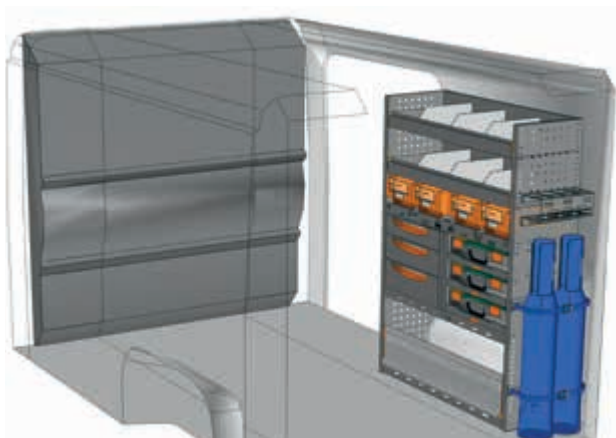
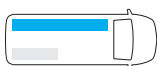

ESEMPIO - EXEMPLE

DU 1014 P1\*

L=1016 P=365 H=1400 mm

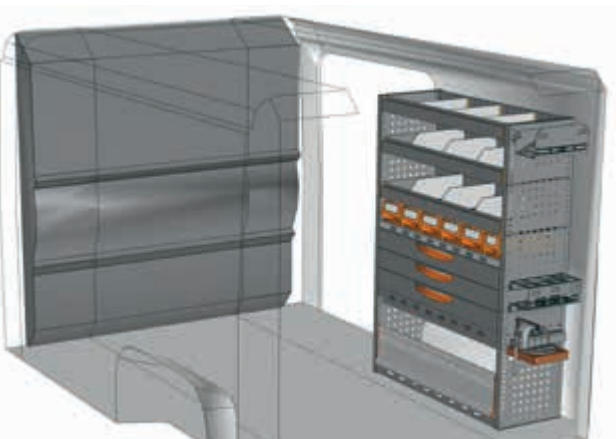

ESEMPIO - EXEMPLE

DU 1014 P2\*

L=1016 P=365 H=1400 mm

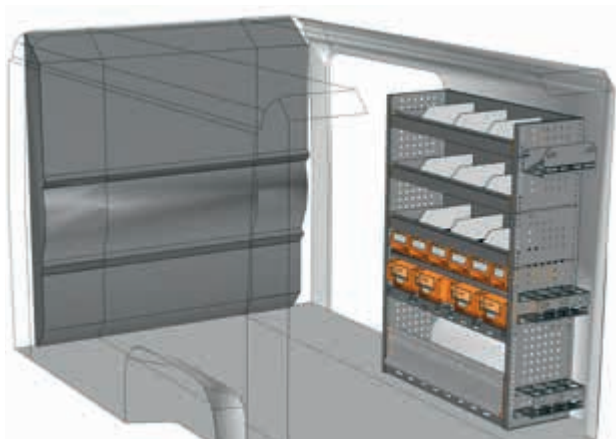

ESEMPIO - EXEMPLE

DU 1014 P3\*

L=1016 P=365 H=1400 mm

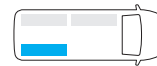

\* Kit fissaggio incluso - Jeu de fixation inclus



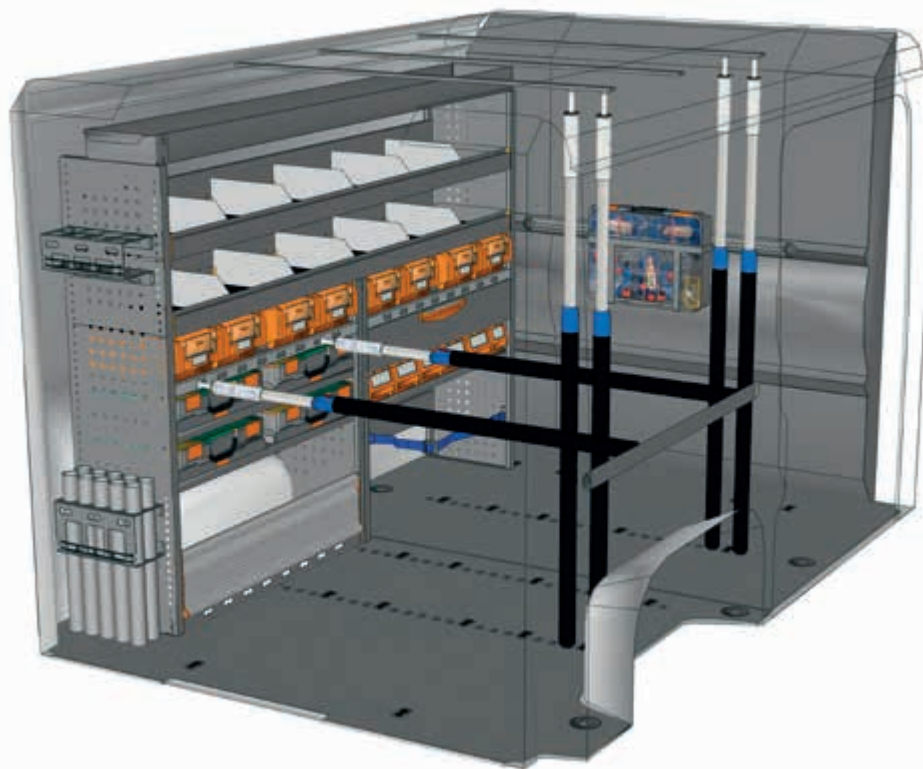
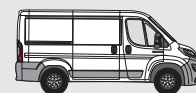

ESEMPIO - EXEMPLE

EXAMPLE DU L1H1 P1\*



- |                         |                         |
|-------------------------|-------------------------|
| 1 x DU 2015 P3          | 1 x F22 SB BOX080 00 01 |
| 1 x F22 SF DU10G1 A0 1S | 1 x F22 SB CPV080 00 01 |
| 1 x F22 VT V22585 00 08 | 2 x F22 FC V22136 00 00 |
| 6 x F22 FC V22131 00 00 | 2 x F22 FC V22124 00 00 |
| 1 x F22 FC V18029 15 00 | 2 x F22 FC V22148 00 00 |
| 1 x F22 FC V18029 10 00 | 1 x F22 SB YELLOW 63 05 |
| 4 x F22 FC V22106 00 00 | 4 x F22 FC V22582 00 00 |
| 3 x F22 FC V18025 15 00 |                         |

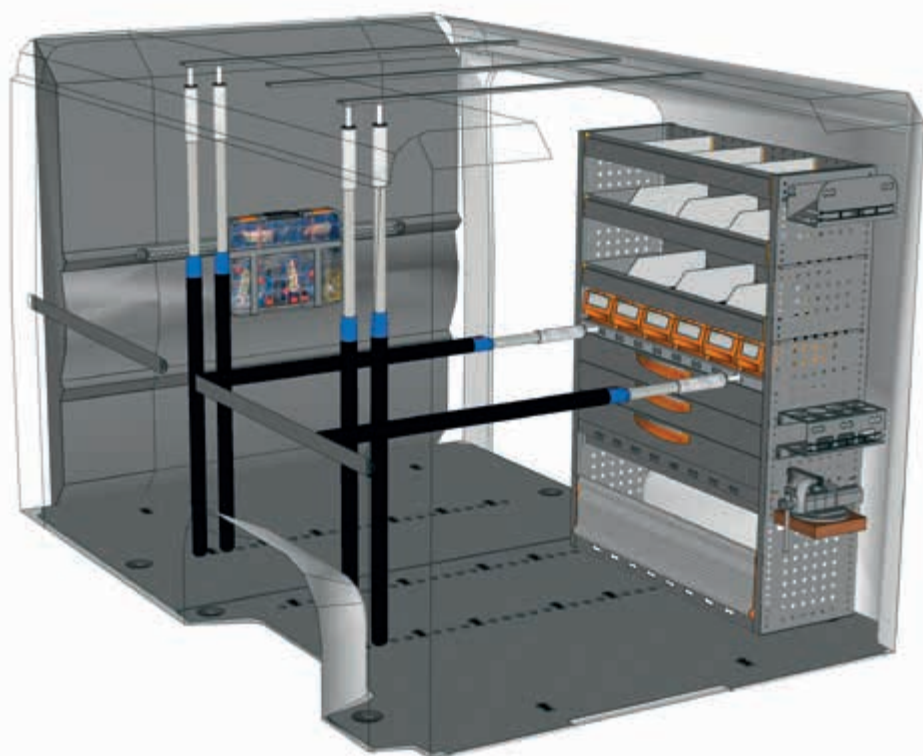

ESEMPIO - EXEMPLE

EXAMPLE DU L1H1 P2\*



- |                         |                         |
|-------------------------|-------------------------|
| 1 x DU 1014 P2          | 1 x F22 SB BOX080 00 01 |
| 1 x F22 SF DU10G1 A0 1S | 1 x F22 SB CPV080 00 01 |
| 1 x F22 VT V22585 00 08 | 2 x F22 FC V22136 00 00 |
| 6 x F22 FC V22131 00 00 | 2 x F22 FC V22124 00 00 |
| 2 x F22 FC V18029 15 00 | 2 x F22 FC V22148 00 00 |
| 1 x F22 FC V18029 10 00 | 1 x F22 SB YELLOW 63 05 |
| 6 x F22 FC V22106 00 00 | 4 x F22 FC V22582 00 00 |
| 3 x F22 FC V18025 15 00 |                         |



vedi pag. 12/13  
voir page 12/13

\* Kit fissaggio incluso - Jeu de fixation inclus

**Non hai trovato il tuo allestimento?**  
**Affidati ai nostri professionisti**  
Guarda il retro di questo catalogo e  
contatta il punto Store Van piu vicino  
oppure visita il nostro sito.

**Vous n'avez pas trouvé votre  
équipement ? Confiez-vous  
à nos professionnels**  
Voir au dos de ce catalogue  
et contactez le point StoreVan  
le plus proche ou visitez notre site web.





L1 H1

PEUGEOT BOXER  
FURGONE LAMIERATO - FOURGON TÔLÉ

MOBILE

# L1 H1 MOBILE

ESEMPI DI ALLESTIMENTO - EXEMPLES D'AMÉNAGEMENTS

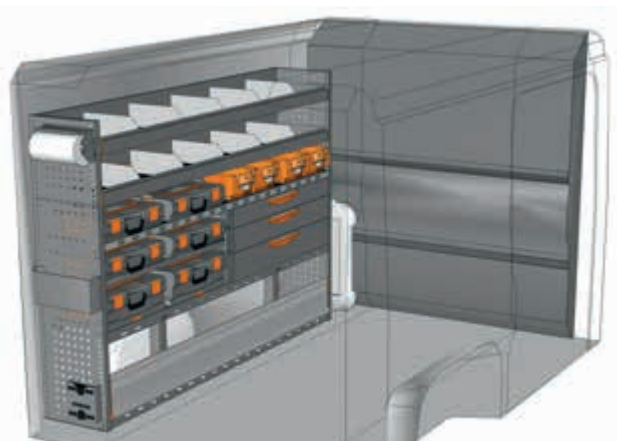

ESEMPIO - EXEMPLE

**DU 2014 M1\***

L=2032 P=365 H=1400 mm

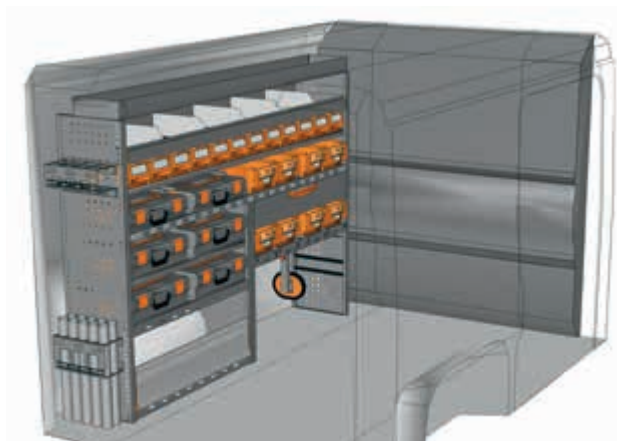
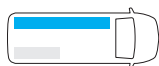

ESEMPIO - EXEMPLE

**DU 2015 M2\***

L=2032 P=365 H=1490 mm

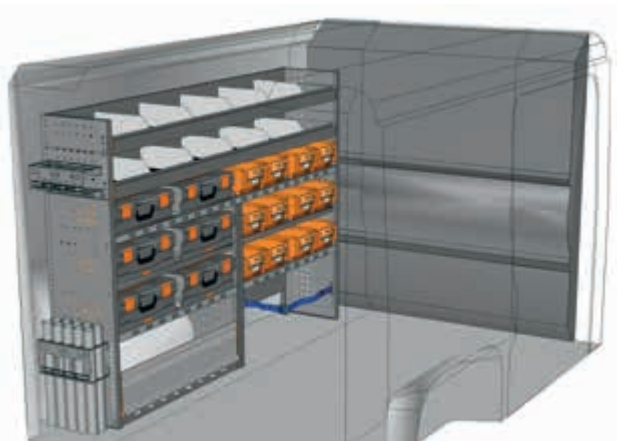
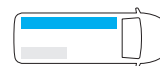

ESEMPIO - EXEMPLE

**DU 2014 M3\***

L=2032 P=365 H=1400 mm

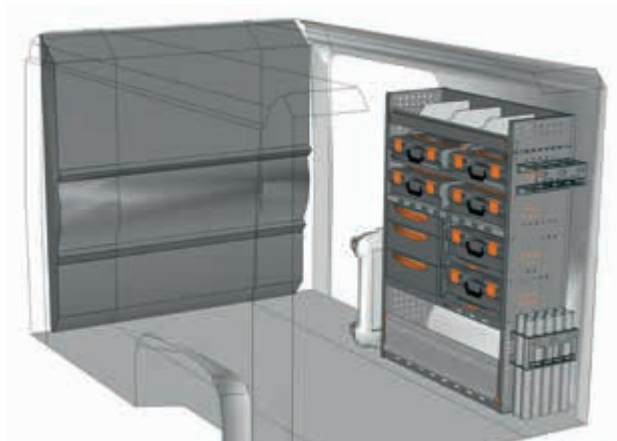
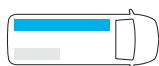

ESEMPIO - EXEMPLE

**DU 1014 M1\***

L=1016 P=365 H=1400 mm

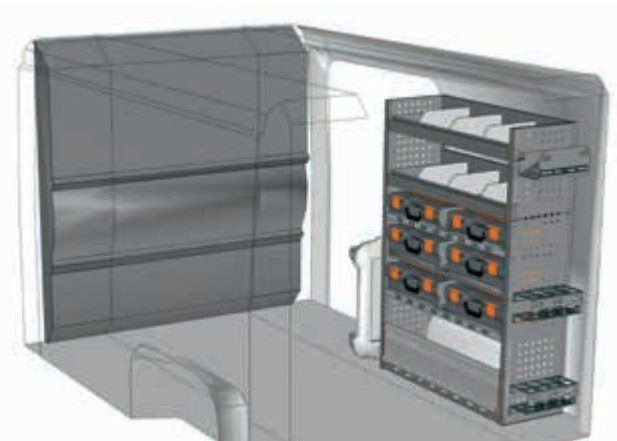
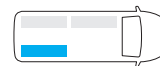

ESEMPIO - EXEMPLE

**DU 1014 M2\***

L=1016 P=365 H=1400 mm

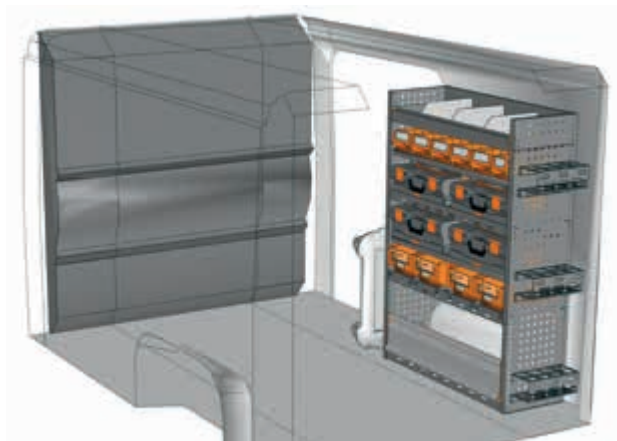

ESEMPIO - EXEMPLE

**DU 1014 M3\***

L=1016 P=365 H=1400 mm

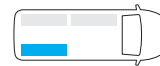

\* Kit fissaggio incluso - Jeu de fixation inclus

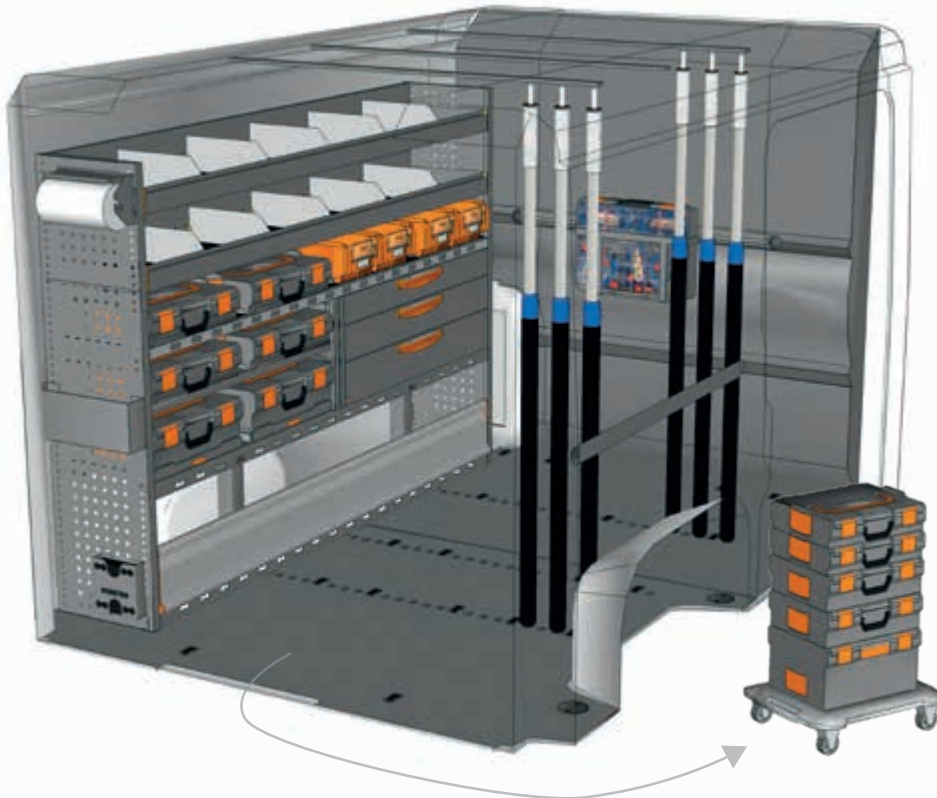

ESEMPIO - EXEMPLE

EXEMPLE DU L1H1 M1\*



- |                         |                         |
|-------------------------|-------------------------|
| 1 x DU 2014 M1          | 1 x F22 SB BOX080 00 01 |
| 1 x F22 SF DU10G1 A0 1S | 1 x F22 SB CPV080 00 01 |
| 1 x F22 VT V22585 00 08 | 2 x F22 FC V22136 00 00 |
| 6 x F22 FC V22131 00 00 | 2 x F22 FC V22124 00 00 |
| 1 x F22 FC V18029 15 00 | 2 x F22 FC V22148 00 00 |
| 1 x F22 FC V18029 10 00 | 1 x F22 SB YELLOW 63 05 |
| 4 x F22 FC V22106 00 00 | 4 x F22 FC V22582 00 00 |
| 3 x F22 FC V18025 15 00 |                         |

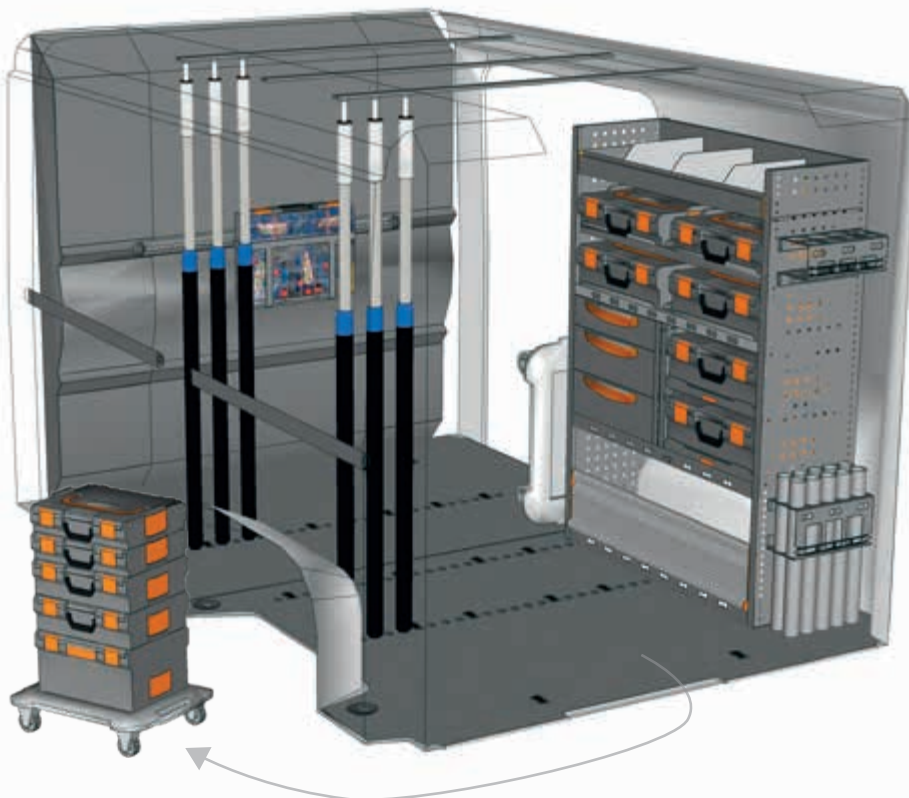

ESEMPIO - EXEMPLE

EXEMPLE DU L1H1 M2\*



- |                         |                         |
|-------------------------|-------------------------|
| 1 x DU 1014 M1          | 1 x F22 SB BOX080 00 01 |
| 1 x F22 SF DU10G1 A0 1S | 1 x F22 SB CPV080 00 01 |
| 1 x F22 VT V22585 00 08 | 2 x F22 FC V22136 00 00 |
| 6 x F22 FC V22131 00 00 | 2 x F22 FC V22124 00 00 |
| 2 x F22 FC V18029 15 00 | 2 x F22 FC V22148 00 00 |
| 1 x F22 FC V18029 10 00 | 1 x F22 SB YELLOW 63 05 |
| 6 x F22 FC V22106 00 00 | 4 x F22 FC V22582 00 00 |
| 3 x F22 FC V18025 15 00 |                         |



vedi pag. 12/13  
voir page 12/13

\* Kit fissaggio incluso - Jeu de fixation inclus

**Non hai trovato il tuo allestimento?**  
**Affidati ai nostri professionisti**  
Guarda il retro di questo catalogo e  
contatta il punto Store Van piu vicino  
oppure visita il nostro sito.

**Vous n'avez pas trouvé votre  
équipement ? Confiez-vous  
à nos professionnels**  
Voir au dos de ce catalogue  
et contactez le point StoreVan  
le plus proche ou visitez notre site web.



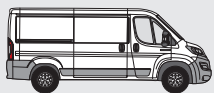

L2 H1

PEUGEOT BOXER  
FURGONE LAMIERATO - FOURGON TÔLÉ

SAFETY

# L2 H1 SAFETY

ESEMPI DI ALLESTIMENTO - EXEMPLES D'AMÉNAGEMENTS

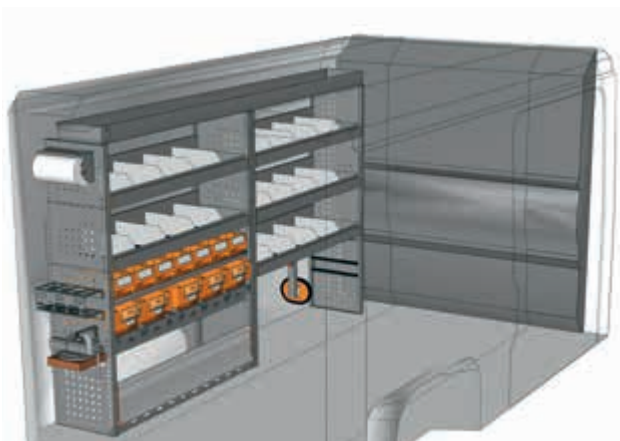

ESEMPIO - EXEMPLE

**DU 2415 02\***

L=2450 P=365 H=1490 mm

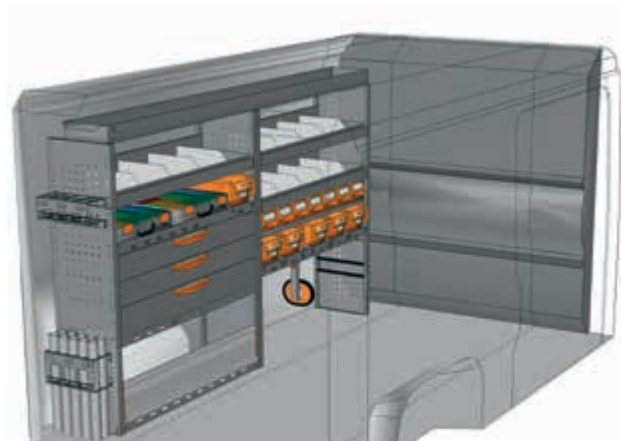
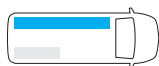

ESEMPIO - EXEMPLE

**DU 2415 03\***

L=2450 P=365 H=1490 mm

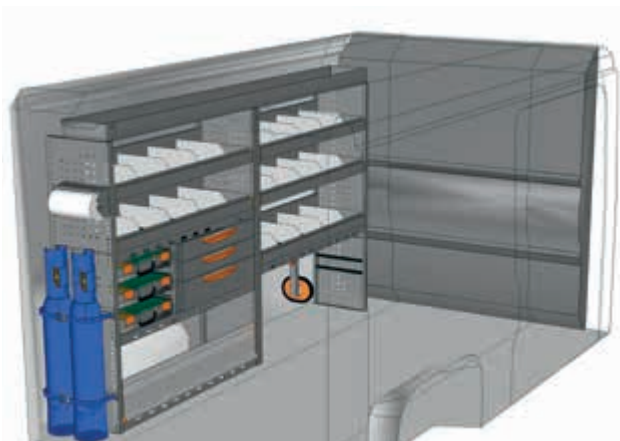
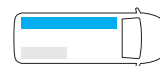

ESEMPIO - EXEMPLE

**DU 2415 04\***

L=2450 P=365 H=1490 mm

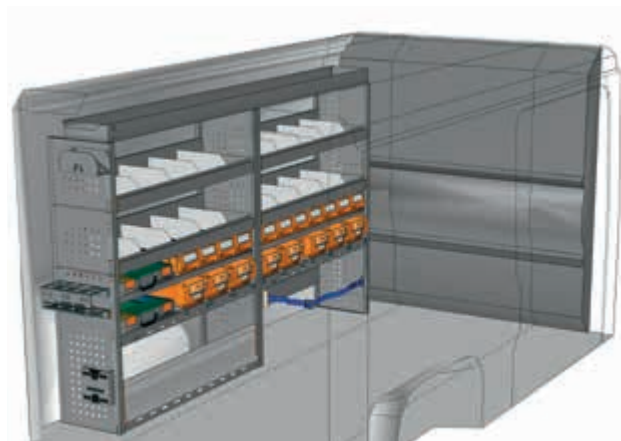
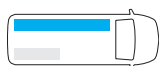

ESEMPIO - EXEMPLE

**DU 2415 05\***

L=2450 P=365 H=1490 mm

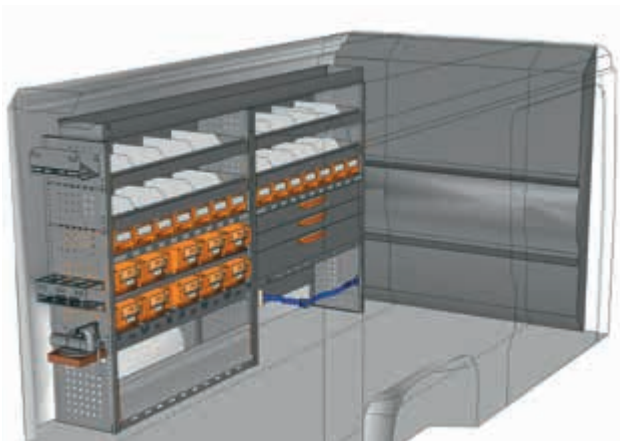
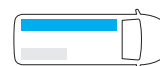

ESEMPIO - EXEMPLE

**DU 2415 06\***

L=2450 P=365 H=1490 mm

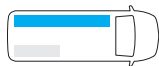

\* Kit fissaggio incluso - Jeu de fixation inclus

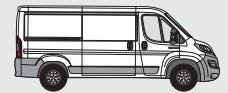

ESEMPI DI ALLESTIMENTO - EXEMPLES D'AMÉNAGEMENTS

SAFETY

L2 H1

FURGONE LAMIERATO - FOURGON TÔLE  
PEUGEOT BOXER

SAFETY



ESEMPIO - EXEMPLE

DU 1214 01\*

L=1225 P=365 H=1400 mm

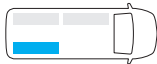

Vista da porta laterale  
Vue de porte latérale



ESEMPIO - EXEMPLE

DU 1214 02\*

L=1225 P=365 H=1400 mm

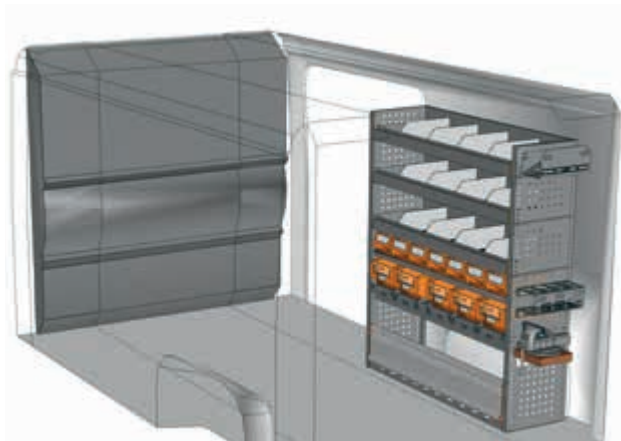
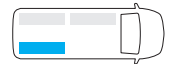

ESEMPIO - EXEMPLE

DU 1214 04\*

L=1225 P=365 H=1400 mm

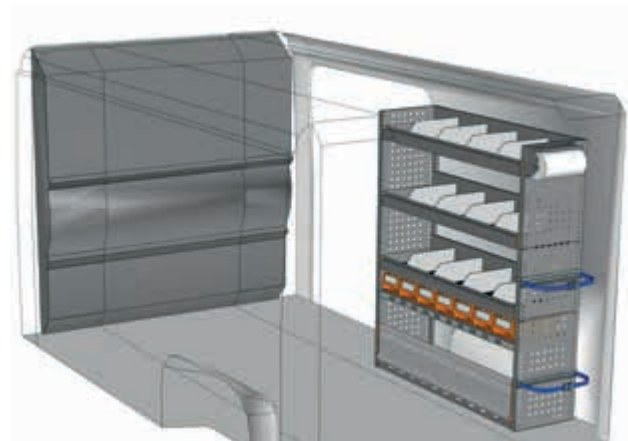

ESEMPIO - EXEMPLE

DU 1214 05\*

L=1225 P=365 H=1400 mm



ESEMPIO - EXEMPLE

DU 1214 09\*

L=1225 P=365 H=1400 mm

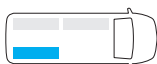

**Non hai trovato il tuo allestimento?**  
**Affidati ai nostri professionisti**  
Guarda il retro di questo catalogo e  
contatta il punto Store Van piu vicino  
oppure visita il nostro sito.

**Vous n'avez pas trouvé votre  
équipement ? Confiez-vous  
à nos professionnels**  
Voir au dos de ce catalogue  
et contactez le point StoreVan  
le plus proche ou visitez notre site web.



\* Kit fissaggio incluso - Jeu de fixation inclus

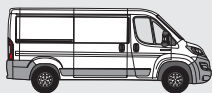

L2 H1

PEUGEOT BOXER  
FURGONE LAMIERATO - FOURGON TÔLÉ

PROFESSIONAL

# L2 H1 PROFESSIONAL

ESEMPI DI ALLESTIMENTO - EXEMPLES D'AMÉNAGEMENTS

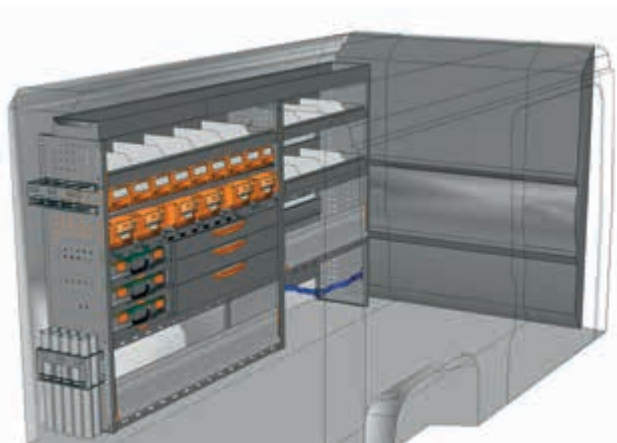

ESEMPIO - EXEMPLE

**DU 2515 P1\***

L=2540 P=365 H=1490 mm

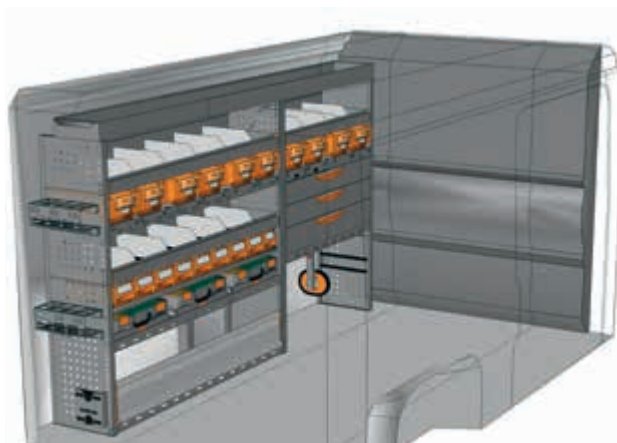
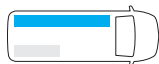

ESEMPIO - EXEMPLE

**DU 2515 P2\***

L=2540 P=365 H=1490 mm

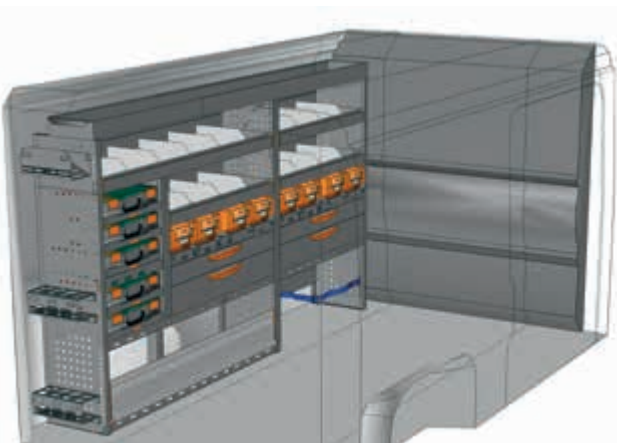
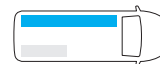

ESEMPIO - EXEMPLE

**DU 2515 P3\***

L=2540 P=365 H=1490 mm

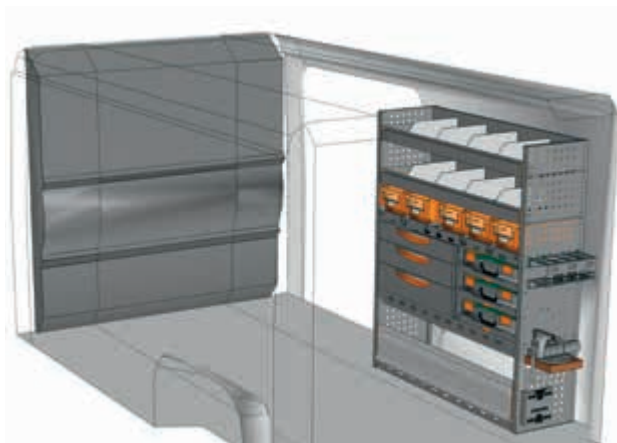
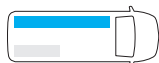

ESEMPIO - EXEMPLE

**DU 1214 P1\***

L=1225 P=365 H=1400 mm

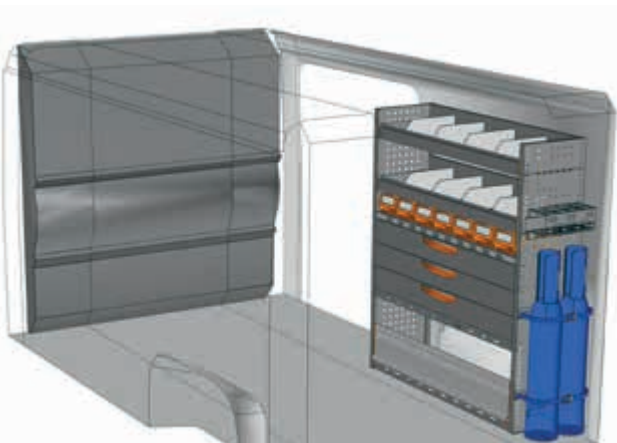

ESEMPIO - EXEMPLE

**DU 1214 P2\***

L=1225 P=365 H=1400 mm

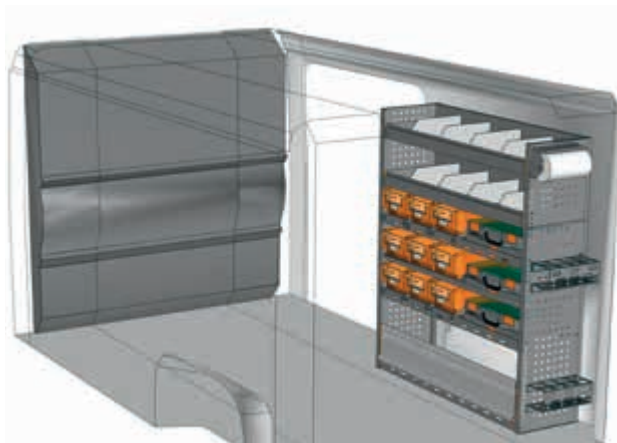

ESEMPIO - EXEMPLE

**DU 1214 P3\***

L=1225 P=365 H=1400 mm

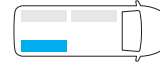

\* Kit fissaggio incluso - Jeu de fixation inclus

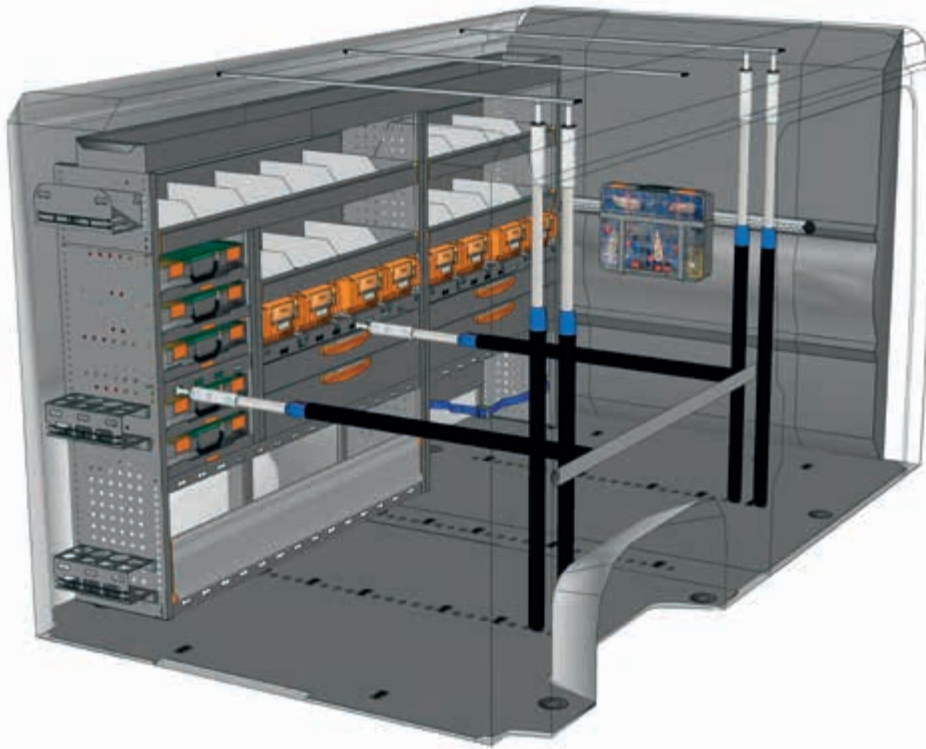
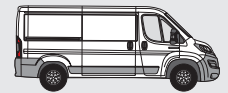

ESEMPIO - EXEMPLE

EXAMPLE DU L2H1 P1\*



- |                         |                         |
|-------------------------|-------------------------|
| 1 x DU 2515 P3          | 1 x F22 SB BOX080 00 01 |
| 1 x F22 SF DU20G1 A0 1S | 1 x F22 SB CPV080 00 01 |
| 1 x F22 VT V22585 00 08 | 2 x F22 FC V22136 00 00 |
| 6 x F22 FC V22131 00 00 | 2 x F22 FC V22124 00 00 |
| 1 x F22 FC V18029 15 00 | 2 x F22 FC V22148 00 00 |
| 1 x F22 FC V18029 10 00 | 1 x F22 SB YELLOW 63 05 |
| 4 x F22 FC V22106 00 00 | 4 x F22 FC V22582 00 00 |
| 3 x F22 FC V18025 15 00 |                         |

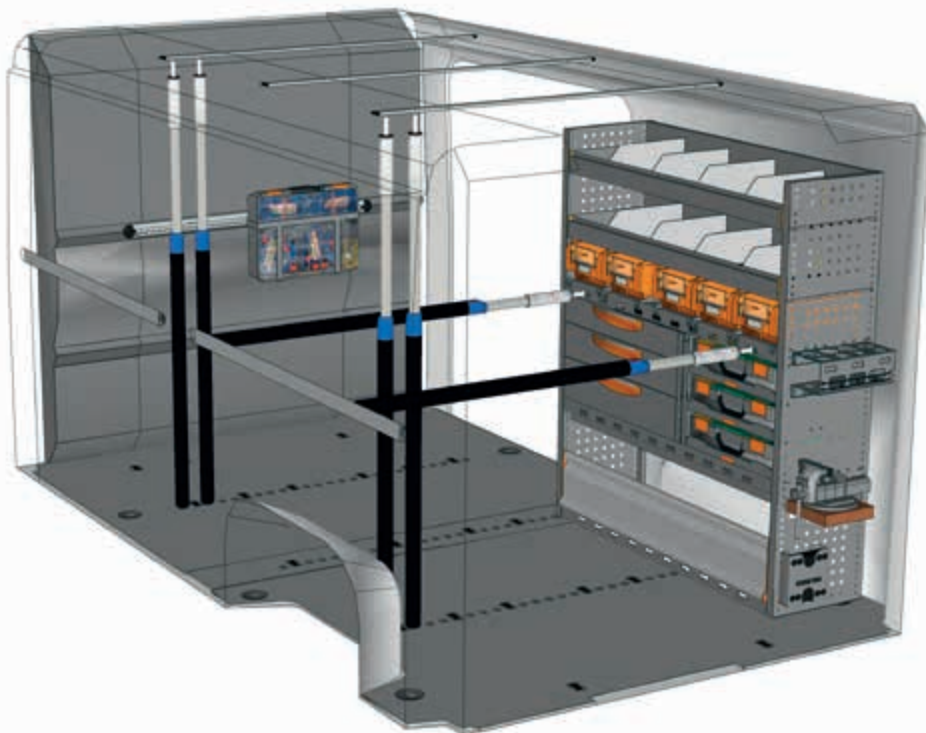

ESEMPIO - EXEMPLE

EXAMPLE DU L2H1 P2\*



- |                         |                         |
|-------------------------|-------------------------|
| 1 x DU 1214 P1          | 1 x F22 SB BOX080 00 01 |
| 1 x F22 SF DU20G1 A0 1S | 1 x F22 SB CPV080 00 01 |
| 1 x F22 VT V22585 00 08 | 2 x F22 FC V22136 00 00 |
| 6 x F22 FC V22131 00 00 | 2 x F22 FC V22124 00 00 |
| 2 x F22 FC V18029 15 00 | 2 x F22 FC V22148 00 00 |
| 1 x F22 FC V18029 10 00 | 1 x F22 SB YELLOW 63 05 |
| 6 x F22 FC V22106 00 00 | 4 x F22 FC V22582 00 00 |
| 3 x F22 FC V18025 15 00 |                         |



vedi pag. 12/13  
voir page 12/13

\* Kit fissaggio incluso - Jeu de fixation inclus

**Non hai trovato il tuo allestimento?**

**Affidati ai nostri professionisti**

Guarda il retro di questo catalogo e  
contatta il punto Store Van piu vicino  
oppure visita il nostro sito.

**Vous n'avez pas trouvé votre  
équipement ? Confiez-vous  
à nos professionnels**

Voir au dos de ce catalogue  
et contactez le point StoreVan  
le plus proche ou visitez notre site web.



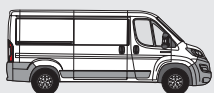

L2 H1

PEUGEOT BOXER  
FURGONE LAMIERATO - FOURGON TÔLÉ

MOBILE

# L2 H1 MOBILE

ESEMPI DI ALLESTIMENTO - EXEMPLES D'AMÉNAGEMENTS

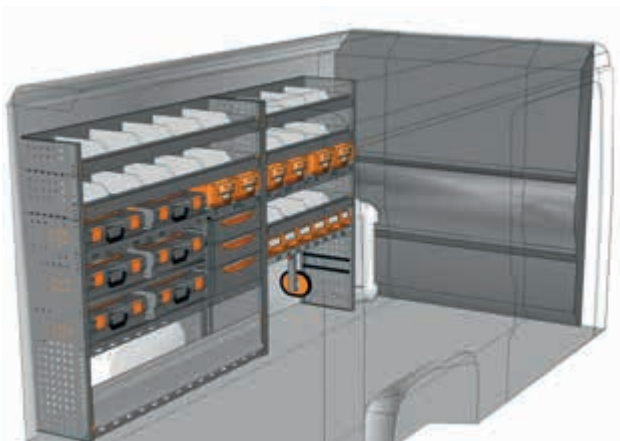

ESEMPIO - EXEMPLE

**DU 2514 M1\***

L=2540 P=365 H=1400 mm

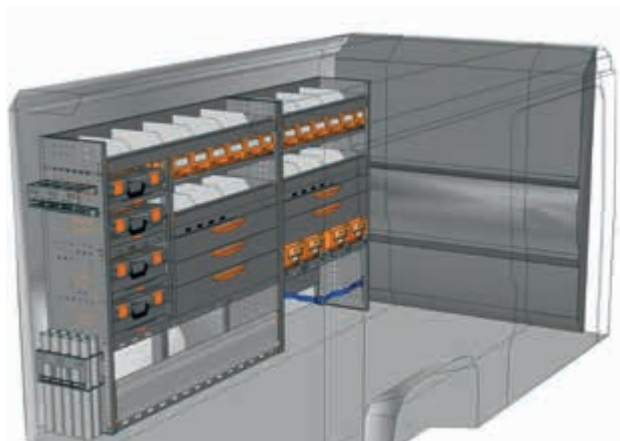
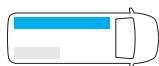

ESEMPIO - EXEMPLE

**DU 2514 M2\***

L=2540 P=365 H=1400 mm

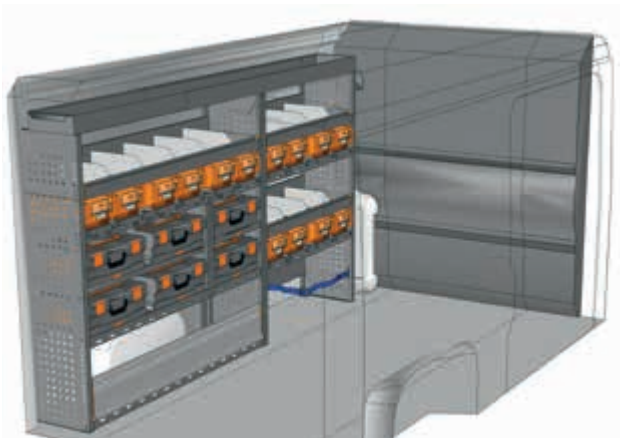
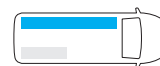

ESEMPIO - EXEMPLE

**DU 2515 M3\***

L=2540 P=365 H=1490 mm

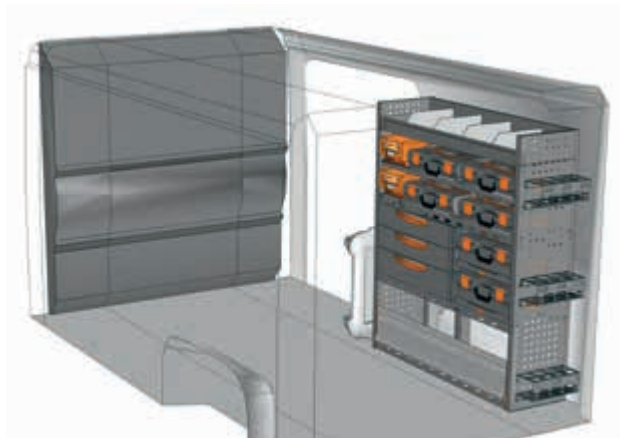
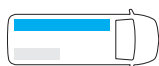

ESEMPIO - EXEMPLE

**DU 1214 M1\***

L=1225 P=365 H=1400 mm

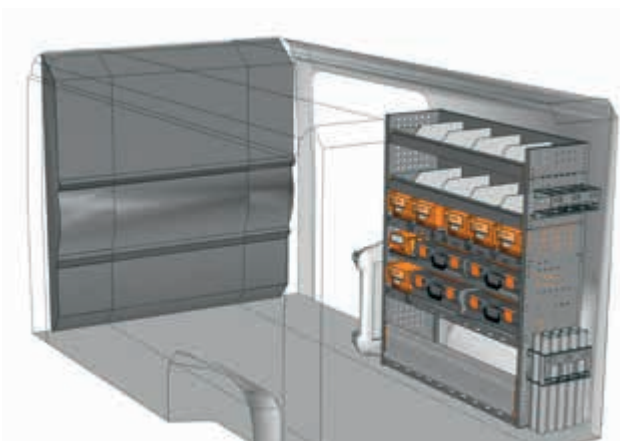
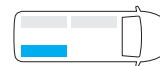

ESEMPIO - EXEMPLE

**DU 1214 M2\***

L=1225 P=365 H=1400 mm

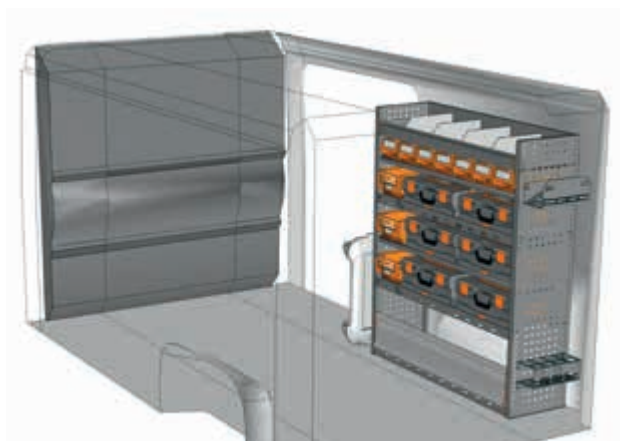
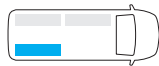

ESEMPIO - EXEMPLE

**DU 1214 M3\***

L=1225 P=365 H=1400 mm

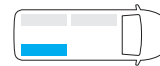

\* Kit fissaggio incluso - Jeu de fixation inclus



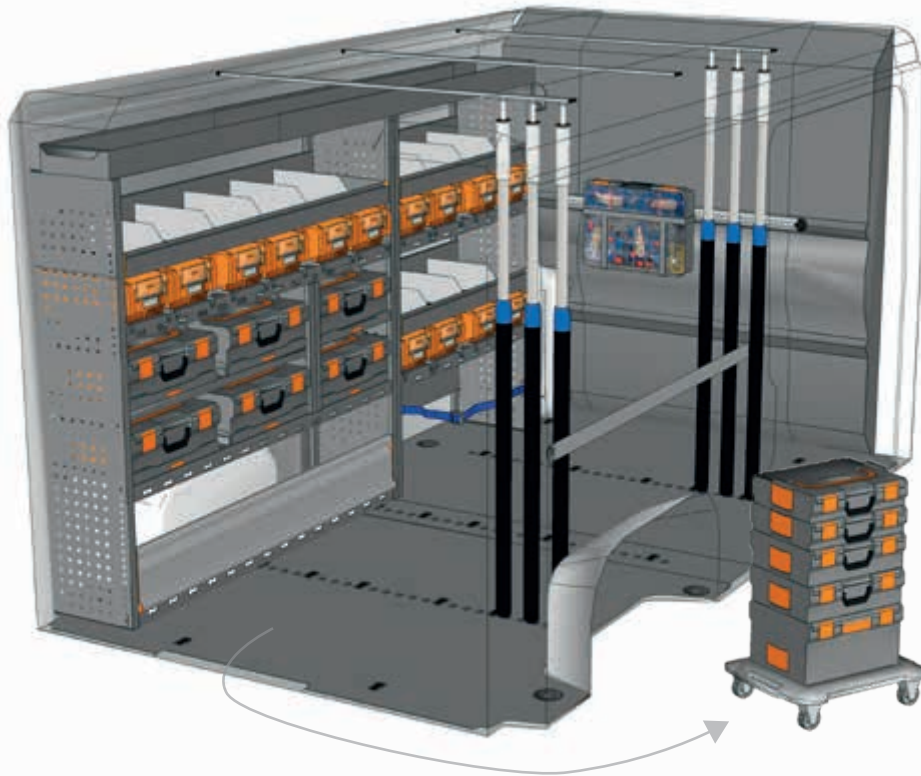
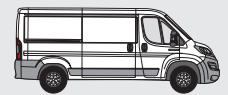

ESEMPIO - EXEMPLE

EXEMPLE DU L2H1 M1\*



- |                         |                         |
|-------------------------|-------------------------|
| 1 x DU 2515 M3          | 1 x F22 SB BOX080 00 01 |
| 1 x F22 SF DU20G1 A0 1S | 1 x F22 SB CPV080 00 01 |
| 1 x F22 VT V22585 00 08 | 2 x F22 FC V22136 00 00 |
| 6 x F22 FC V22131 00 00 | 2 x F22 FC V22124 00 00 |
| 1 x F22 FC V18029 15 00 | 2 x F22 FC V22148 00 00 |
| 1 x F22 FC V18029 10 00 | 1 x F22 SB YELLOW 63 05 |
| 4 x F22 FC V22106 00 00 | 4 x F22 FC V22582 00 00 |
| 3 x F22 FC V18025 15 00 |                         |

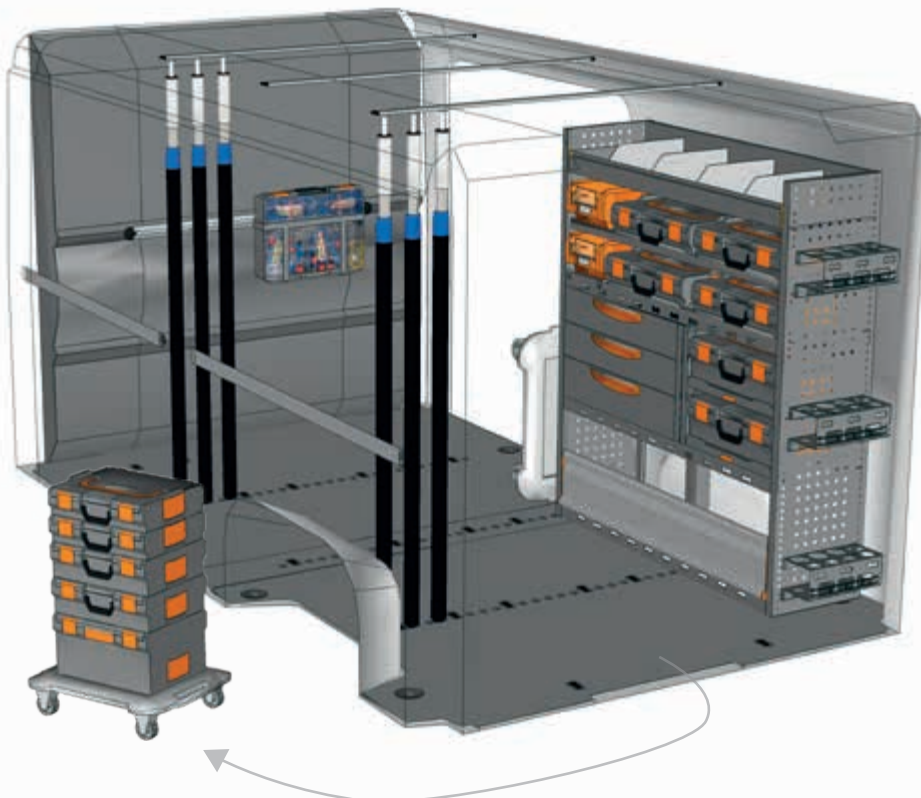

ESEMPIO - EXEMPLE

EXEMPLE DU L2H1 M2\*



- |                         |                         |
|-------------------------|-------------------------|
| 1 x DU 1214 M1          | 1 x F22 SB BOX080 00 01 |
| 1 x F22 SF DU20G1 A0 1S | 1 x F22 SB CPV080 00 01 |
| 1 x F22 VT V22585 00 08 | 2 x F22 FC V22136 00 00 |
| 6 x F22 FC V22131 00 00 | 2 x F22 FC V22124 00 00 |
| 2 x F22 FC V18029 15 00 | 2 x F22 FC V22148 00 00 |
| 1 x F22 FC V18029 10 00 | 1 x F22 SB YELLOW 63 05 |
| 6 x F22 FC V22106 00 00 | 4 x F22 FC V22582 00 00 |
| 3 x F22 FC V18025 15 00 |                         |

**Non hai trovato il tuo allestimento?**

**Affidati ai nostri professionisti**

Guarda il retro di questo catalogo e  
contatta il punto Store Van piu vicino  
oppure visita il nostro sito.

**Vous n'avez pas trouvé votre  
équipement ? Confiez-vous  
à nos professionnels**

Voir au dos de ce catalogue  
et contactez le point StoreVan  
le plus proche ou visitez notre site web.



vedi pag. 12/13  
voir page 12/13

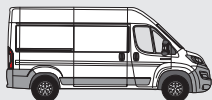

L2 H2

PEUGEOT BOXER  
FURGONE LAMIERATO - FOURGON TÔLÉ

SAFETY

# L2 H2 SAFETY

ESEMPI DI ALLESTIMENTO - EXEMPLES D'AMÉNAGEMENTS

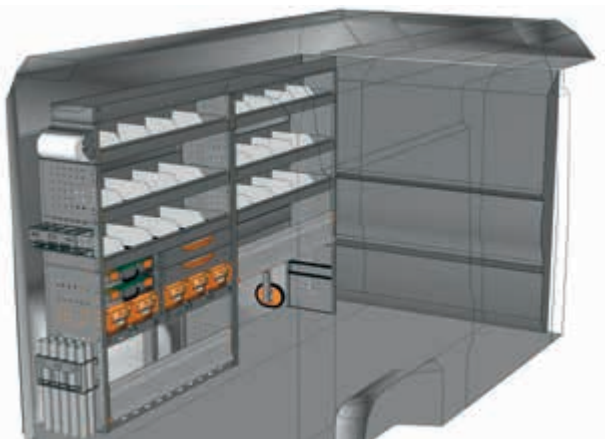

ESEMPIO - EXEMPLE

**DU 2417 01\***

L=2450 P=365 H=1690 mm

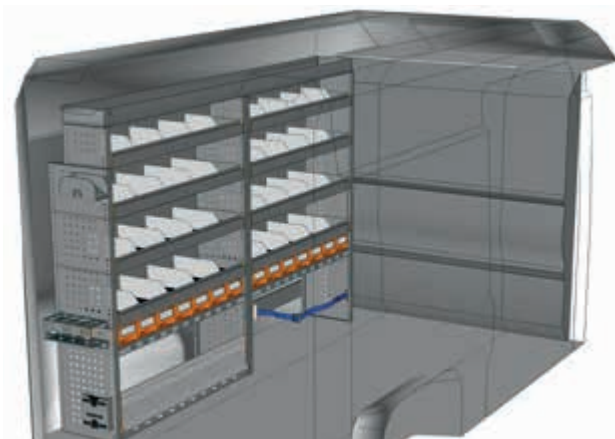
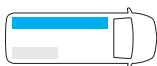

ESEMPIO - EXEMPLE

**DU 2417 02\***

L=2450 P=365 H=1690 mm

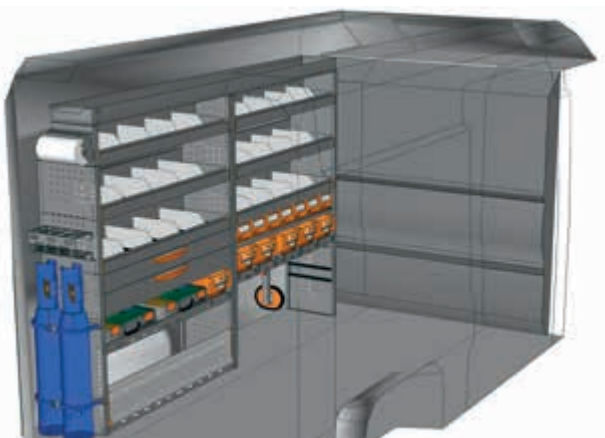
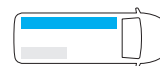

ESEMPIO - EXEMPLE

**DU 2417 04\***

L=2450 P=365 H=1690 mm

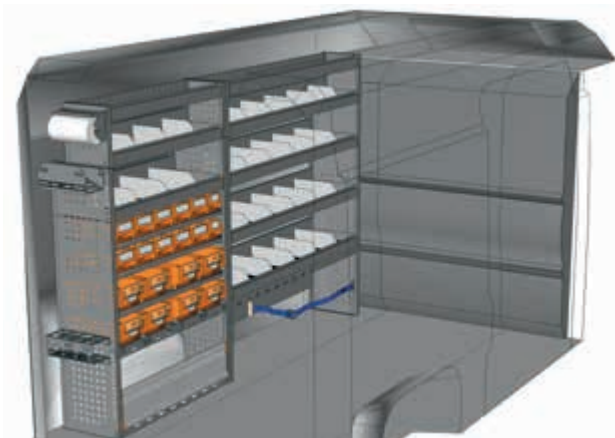
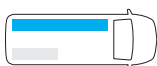

ESEMPIO - EXEMPLE

**DU 2517 05\***

L=2540 P=365 H=1700 mm



ESEMPIO - EXEMPLE

**DU 2517 04\***

L=2540 P=365 H=1700 mm

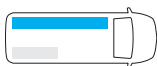

\* Kit fissaggio incluso - Jeu de fixation inclus



ESEMPI DI ALLESTIMENTO - EXEMPLES D'AMÉNAGEMENTS

SAFETY

L2 H2

FURGONE LAMIERATO - FOURGON TÔLE  
PEUGEOT BOXER

SAFETY



ESEMPIO - EXEMPLE

DU 1217 01\*

L=1225 P=365 H=1700 mm

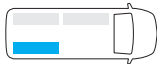

Vista da porta laterale  
Vue de porte latérale



ESEMPIO - EXEMPLE

DU 1217 02\*

L=1225 P=365 H=1700 mm



ESEMPIO - EXEMPLE

DU 1217 04\*

L=1225 P=365 H=1700 mm

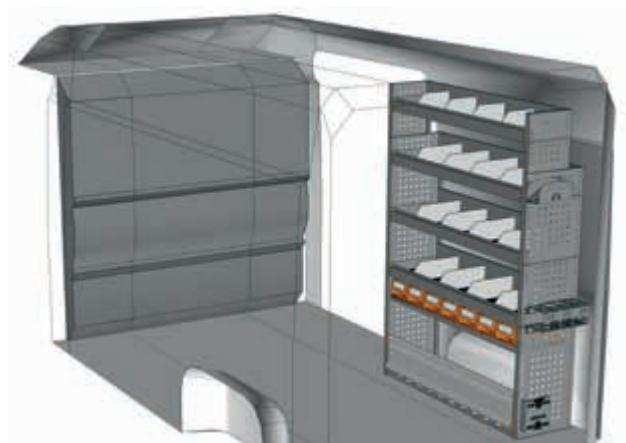
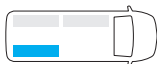

ESEMPIO - EXEMPLE

DU 1217 05\*

L=1225 P=365 H=1700 mm

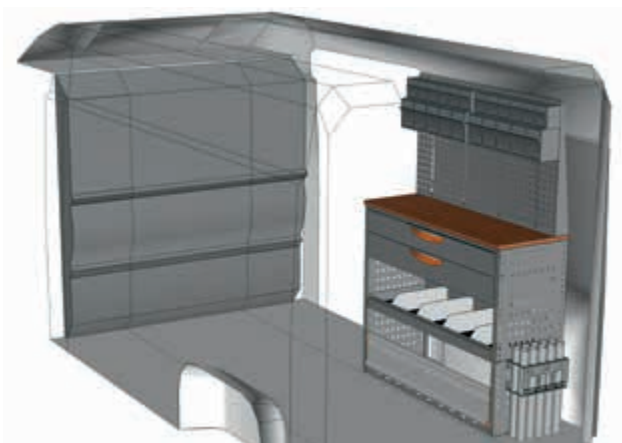

ESEMPIO - EXEMPLE

DU 1217 10\*

L=1225 P=445 H=1725 mm

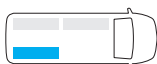

**Non hai trovato il tuo allestimento?**

**Affidati ai nostri professionisti**

Guarda il retro di questo catalogo e  
contatta il punto Store Van piu vicino  
oppure visita il nostro sito.

**Vous n'avez pas trouvé votre  
équipement ? Confiez-vous  
à nos professionnels**

Voir au dos de ce catalogue  
et contactez le point StoreVan  
le plus proche ou visitez notre site web.



\* Kit fissaggio incluso - Jeu de fixation inclus

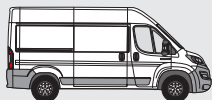

L2 H2

PEUGEOT BOXER  
FURGONE LAMIERATO - FOURGON TÔLÉ

PROFESSIONAL

# L2 H2 PROFESSIONAL

ESEMPI DI ALLESTIMENTO - EXEMPLES D'AMÉNAGEMENTS

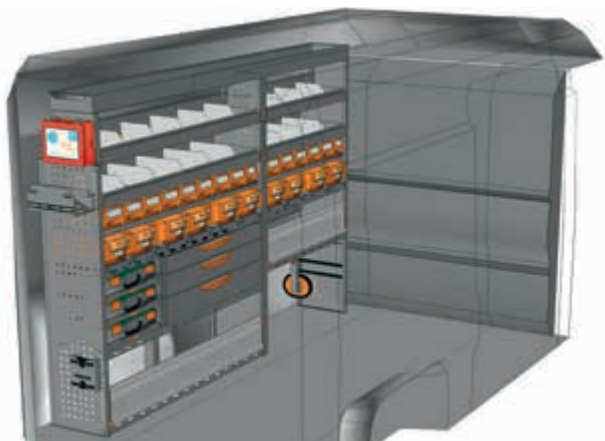

ESEMPIO - EXEMPLE

**DU 2517 P1\***

L=2540 P=365 H=1740 mm

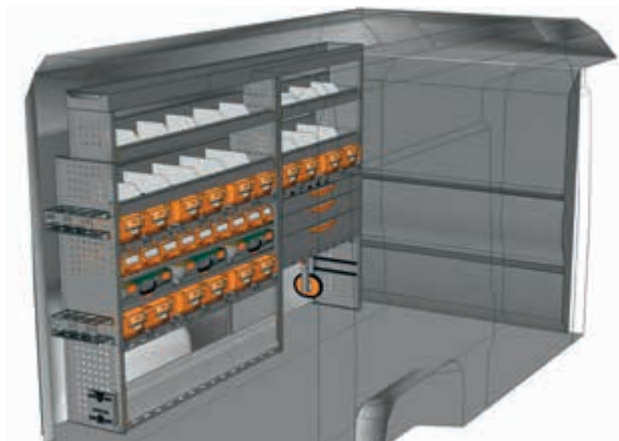
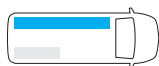

ESEMPIO - EXEMPLE

**DU 2517 P2\***

L=2540 P=365 H=1740 mm

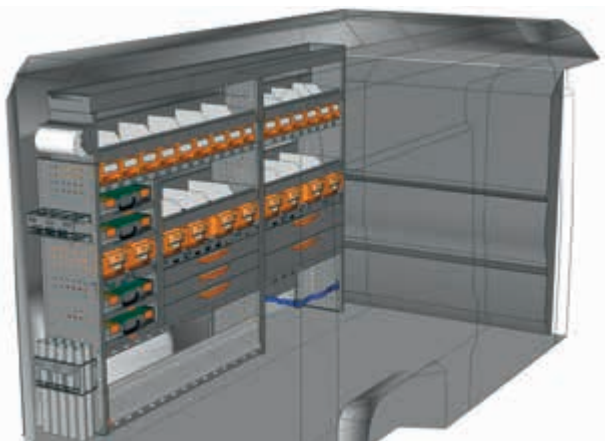
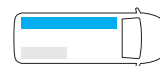

ESEMPIO - EXEMPLE

**DU 2517 P3\***

L=2540 P=365 H=1740 mm

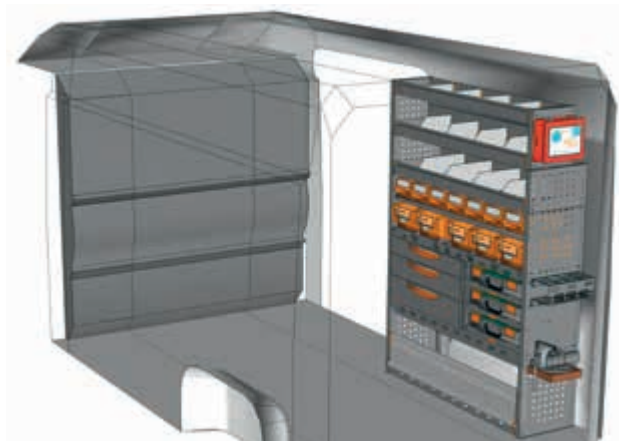
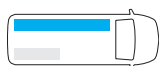

ESEMPIO - EXEMPLE

**DU 1217 P1\***

L=1225 P=365 H=1700 mm

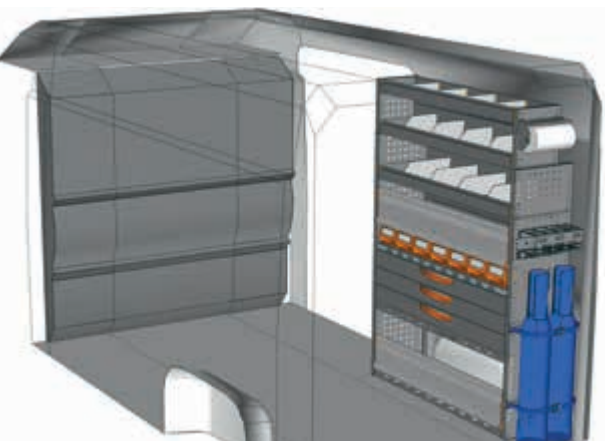
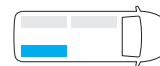

ESEMPIO - EXEMPLE

**DU 1217 P2\***

L=1225 P=365 H=1700 mm

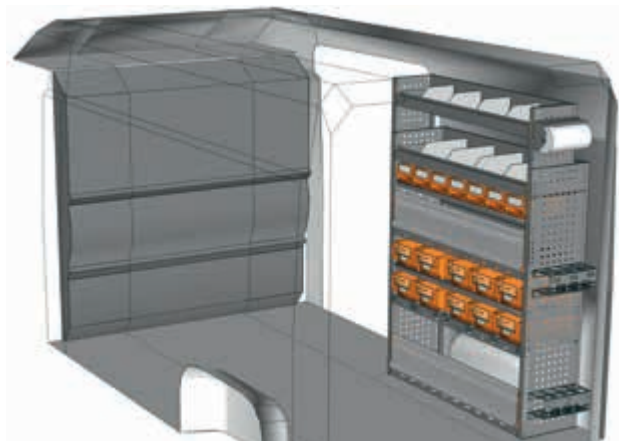

ESEMPIO - EXEMPLE

**DU 1217 P3\***

L=1225 P=365 H=1700 mm

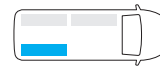

\* Kit fissaggio incluso - Jeu de fixation inclus

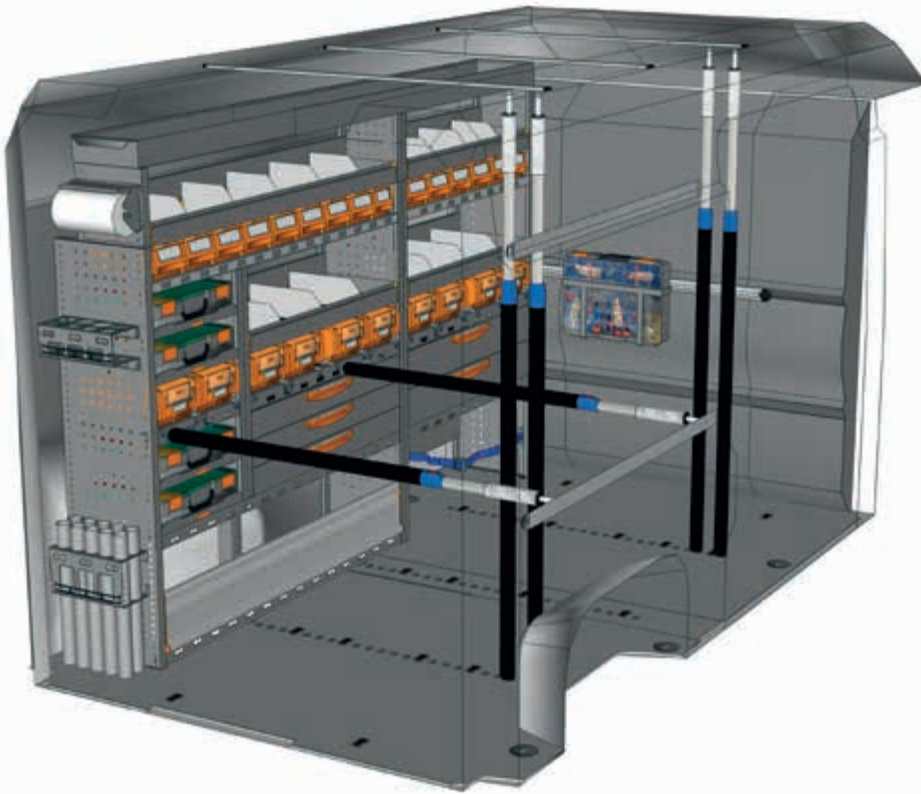
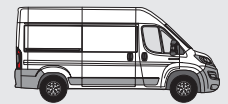

ESEMPIO - EXEMPLE

EXAMPLE DU L2H2 P1\*



- |                         |                         |
|-------------------------|-------------------------|
| 1 x DU 2517 P3          | 3 x F22 FC V18025 15 00 |
| 1 x F22 SF DU20G1 A0 1S | 1 x F22 SB BOX080 00 01 |
| 1 x F22 VT V22585 00 08 | 1 x F22 SB CPV080 00 01 |
| 2 x F22 FC V22131 00 00 | 2 x F22 FC V22136 00 00 |
| 4 x F22 FC V22017 00 00 | 2 x F22 FC V22124 00 00 |
| 2 x F22 FC V18029 15 00 | 2 x F22 FC V22148 00 00 |
| 1 x F22 FC V18029 10 00 | 1 x F22 SB YELLOW 63 05 |
| 6 x F22 FC V22106 00 00 | 4 x F22 FC V22582 00 00 |

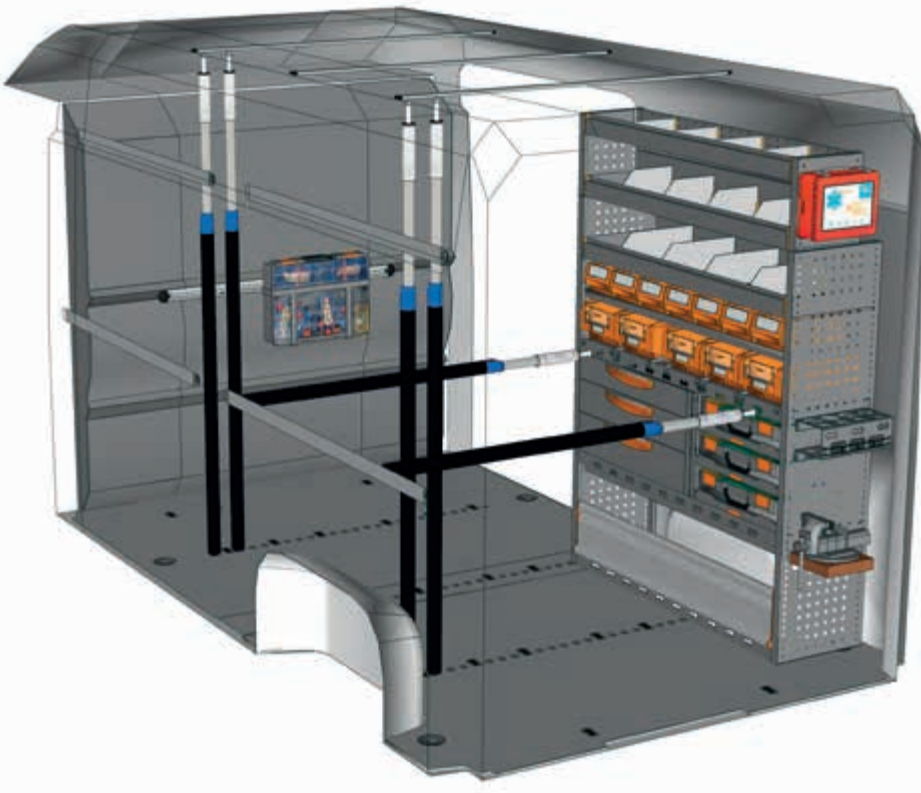

ESEMPIO - EXEMPLE

EXAMPLE DU L2H2 P2\*



- |                          |                         |
|--------------------------|-------------------------|
| 1 x DU 1217 P1           | 3 x F22 FC V18025 15 00 |
| 1 x F22 SF DU20G1 A0 1S  | 1 x F22 SB BOX080 00 01 |
| 1 x F22 VT V22585 00 08  | 1 x F22 SB CPV080 00 01 |
| 2 x F22 FC V22131 00 00  | 2 x F22 FC V22136 00 00 |
| 4 x F22 FC V22017 00 00  | 2 x F22 FC V22124 00 00 |
| 4 x F22 FC V18029 15 00  | 2 x F22 FC V22148 00 00 |
| 1 x F22 FC V18029 10 00  | 1 x F22 SB YELLOW 63 05 |
| 10 x F22 FC V22106 00 00 | 4 x F22 FC V22582 00 00 |

**Non hai trovato il tuo allestimento?**

**Affidati ai nostri professionisti**

Guarda il retro di questo catalogo e  
contatta il punto Store Van piu vicino  
oppure visita il nostro sito.

**Vous n'avez pas trouvé votre  
équipement ? Confiez-vous  
à nos professionnels**

Voir au dos de ce catalogue  
et contactez le point StoreVan  
le plus proche ou visitez notre site web.



vedi pag. 12/13  
voir page 12/13

\* Kit fissaggio incluso - Jeu de fixation inclus

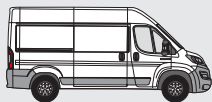

L2 H2

PEUGEOT BOXER  
FURGONE LAMIERATO - FOURGON TÔLE

MOBILE

# L2 H2 MOBILE

ESEMPI DI ALLESTIMENTO - EXEMPLES D'AMÉNAGEMENTS

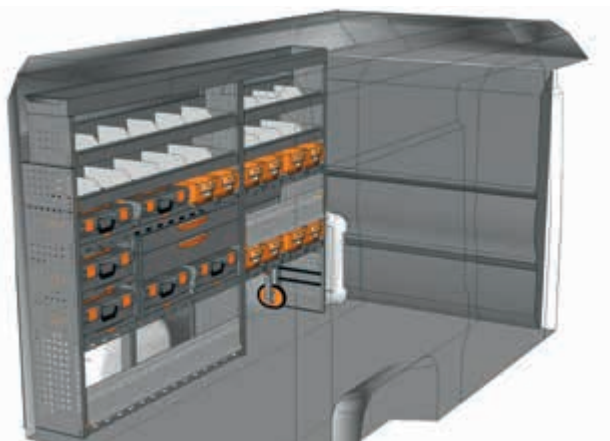

ESEMPIO - EXEMPLE

**DU 2517 M1\***

L=2540 P=365 H=1740 mm

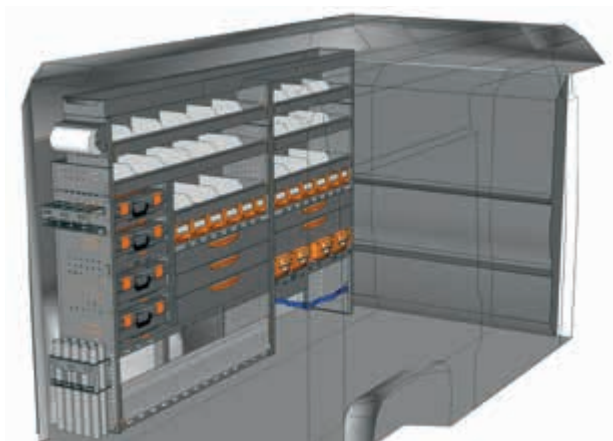
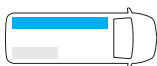

ESEMPIO - EXEMPLE

**DU 2517 M2\***

L=2540 P=365 H=1740 mm

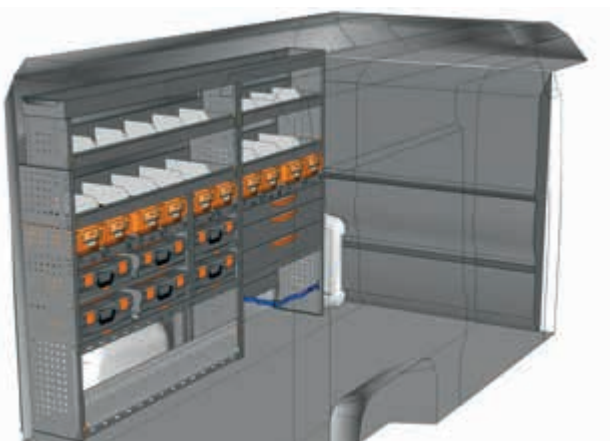
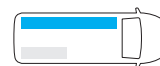

ESEMPIO - EXEMPLE

**DU 2517 M3\***

L=2540 P=365 H=1740 mm

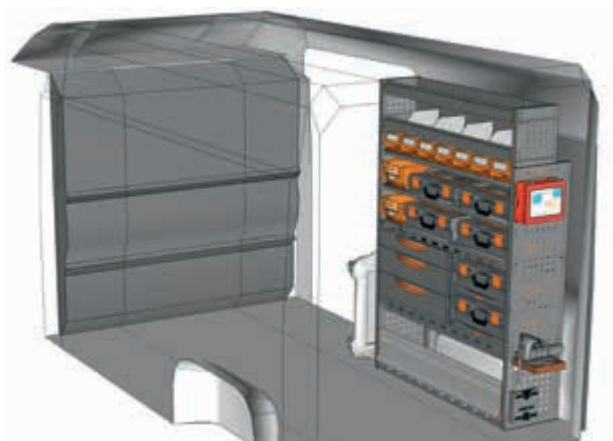
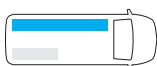

ESEMPIO - EXEMPLE

**DU 1217 M1\***

L=1225 P=365 H=1700 mm

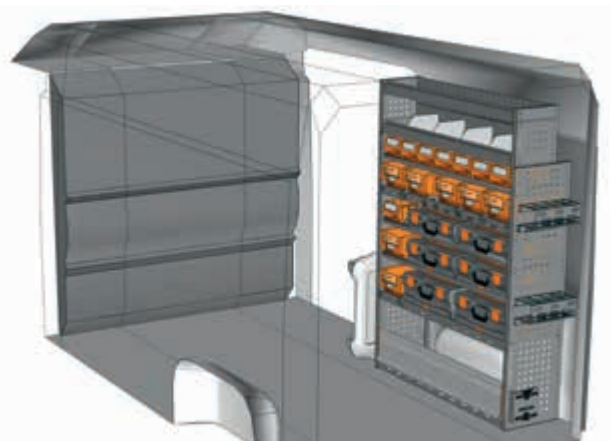
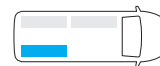

ESEMPIO - EXEMPLE

**DU 1217 M2\***

L=1225 P=365 H=1700 mm

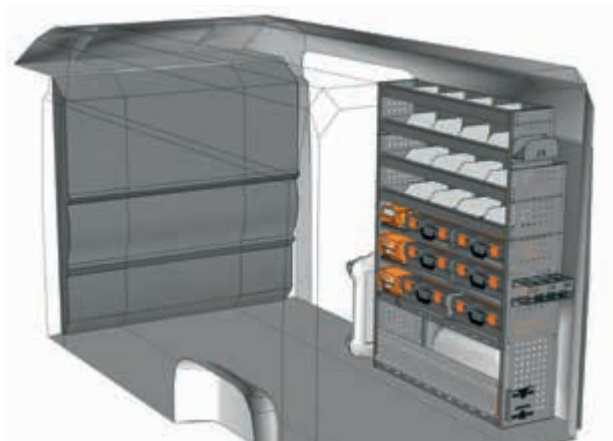
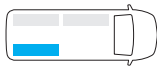

ESEMPIO - EXEMPLE

**DU 1217 M3\***

L=1225 P=365 H=1700 mm

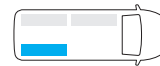

\* Kit fissaggio incluso - Jeu de fixation inclus

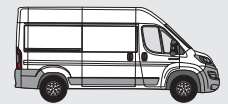

ESEMPI DI ALLESTIMENTO - EXEMPLES D'AMÉNAGEMENTS

MOBILE

L2 H2

FURGONE LAMIERATO - FOURGON TÔLE

MOBILE

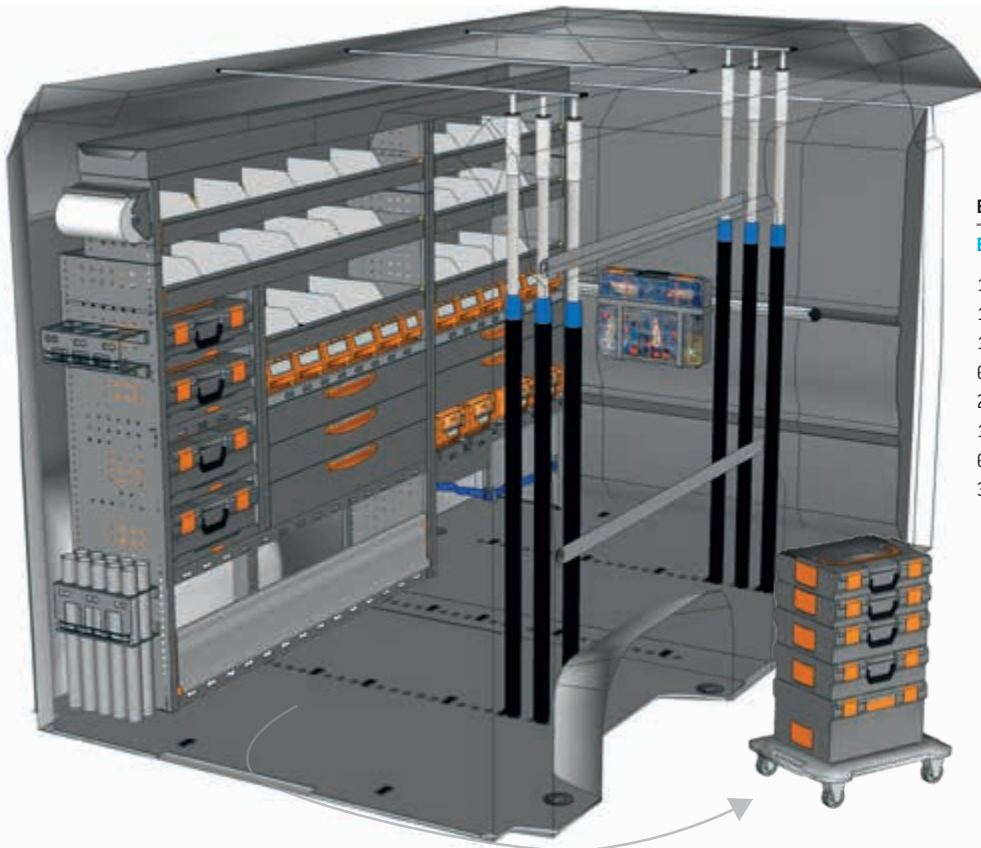

ESEMPIO - EXEMPLE

EXEMPLE DU L2H2 M1\*



- |                         |                         |
|-------------------------|-------------------------|
| 1 x DU 2517 M2          | 1 x F22 SB BOX080 00 01 |
| 1 x F22 SF DU20G1 A0 1S | 1 x F22 SB CPV080 00 01 |
| 1 x F22 VT V22585 00 08 | 2 x F22 FC V22136 00 00 |
| 6 x F22 FC V22017 00 00 | 2 x F22 FC V22124 00 00 |
| 2 x F22 FC V18029 15 00 | 2 x F22 FC V22148 00 00 |
| 1 x F22 FC V18029 10 00 | 1 x F22 SB YELLOW 63 05 |
| 6 x F22 FC V22106 00 00 | 4 x F22 FC V22582 00 00 |
| 3 x F22 FC V18025 15 00 |                         |

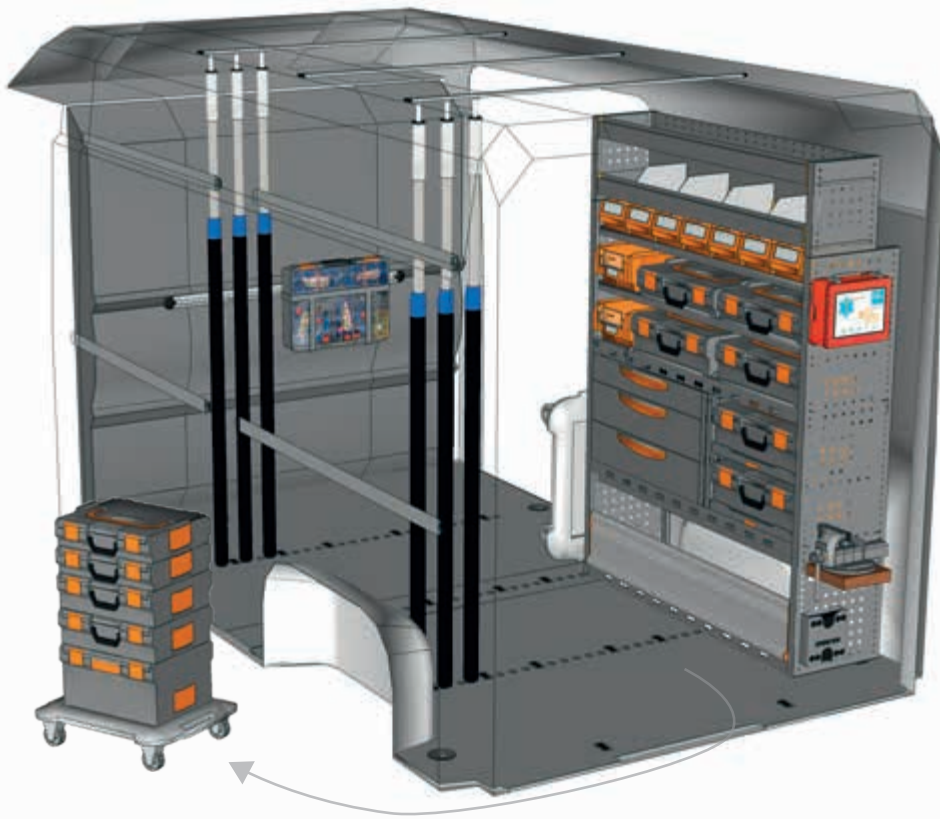

ESEMPIO - EXEMPLE

EXEMPLE DU L2H2 M2\*



- |                          |                         |
|--------------------------|-------------------------|
| 1 x DU 1217 M2           | 1 x F22 SB BOX080 00 01 |
| 1 x F22 SF DU20G1 A0 1S  | 1 x F22 SB CPV080 00 01 |
| 1 x F22 VT V22585 00 08  | 2 x F22 FC V22136 00 00 |
| 6 x F22 FC V22017 00 00  | 2 x F22 FC V22124 00 00 |
| 4 x F22 FC V18029 15 00  | 2 x F22 FC V22148 00 00 |
| 1 x F22 FC V18029 10 00  | 1 x F22 SB YELLOW 63 05 |
| 10 x F22 FC V22106 00 00 | 4 x F22 FC V22582 00 00 |
| 3 x F22 FC V18025 15 00  |                         |



vedi pag. 12/13  
voir page 12/13

\* Kit fissaggio incluso - Jeu de fixation inclus

**Non hai trovato il tuo allestimento?**

**Affidati ai nostri professionisti**

Guarda il retro di questo catalogo e  
contatta il punto Store Van piu vicino  
oppure visita il nostro sito.

**Vous n'avez pas trouvé votre  
équipement ? Confiez-vous  
à nos professionnels**

Voir au dos de ce catalogue  
et contactez le point StoreVan  
le plus proche ou visitez notre site web.



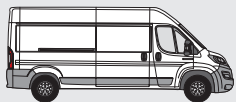

L3 H2

PEUGEOT BOXER  
FURGONE LAMIERATO - FOURGON TÔLÉ

SAFETY

# L3 H2 SAFETY

ESEMPI DI ALLESTIMENTO - EXEMPLES D'AMÉNAGEMENTS

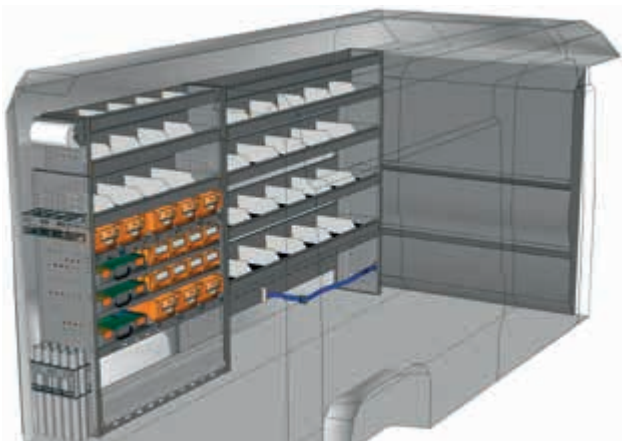

ESEMPIO - EXEMPLE

**DU 3117 01\***

L=3167 P=365 H=1700 mm

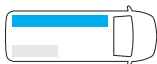

ESEMPIO - EXEMPLE

**DU 3117 04\***

L=3167 P=365 H=1700 mm

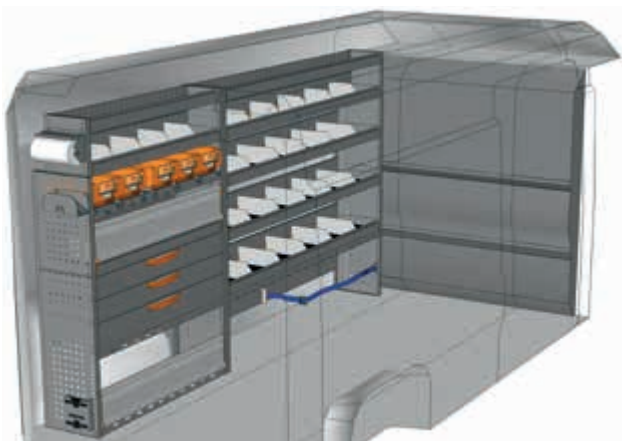

ESEMPIO - EXEMPLE

**DU 3117 03\***

L=3167 P=365 H=1700 mm

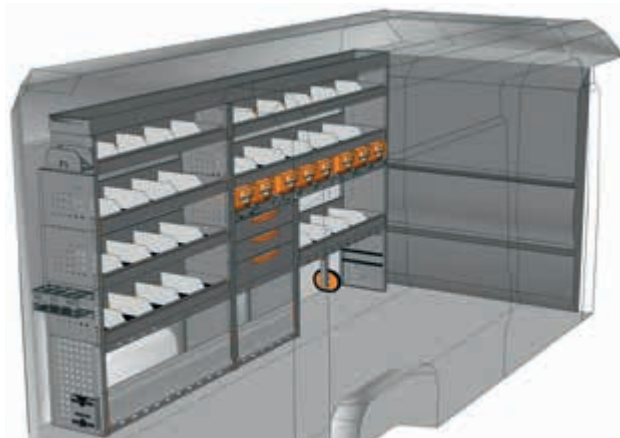
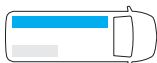

ESEMPIO - EXEMPLE

**DU 3117 07\***

L=3167 P=365 H=1690 mm

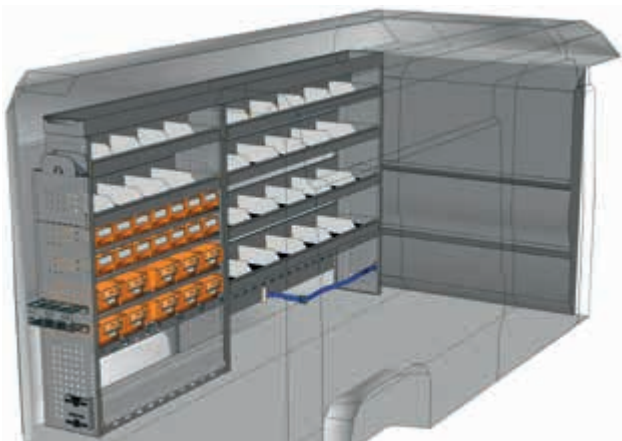
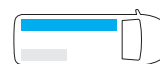

ESEMPIO - EXEMPLE

**DU 3117 06\***

L=3167 P=365 H=1690 mm

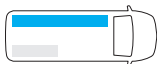

\* Kit fissaggio incluso - Jeu de fixation inclus



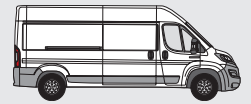

ESEMPI DI ALLESTIMENTO - EXEMPLES D'AMÉNAGEMENTS

SAFETY

L3 H2

FURGONE LAMIERATO - FOURGON TÔLE  
PEUGEOT BOXER

SAFETY

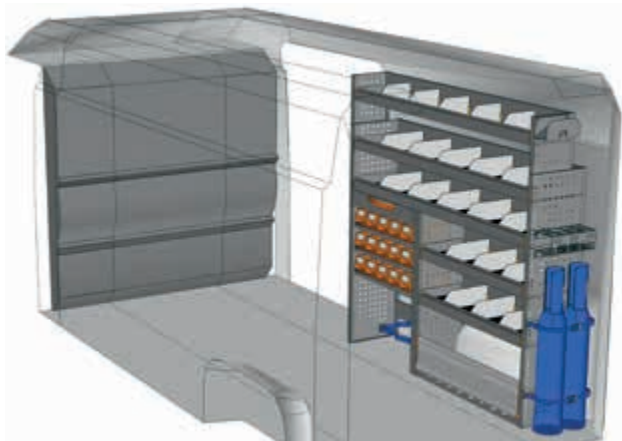

ESEMPIO - EXEMPLE

DU 1717 01\*

L=1733 P=365 H=1700 mm



Vista da porta laterale  
Vue de porte latérale



ESEMPIO - EXEMPLE

DU 1717 03\*

L=1733 P=365 H=1700 mm

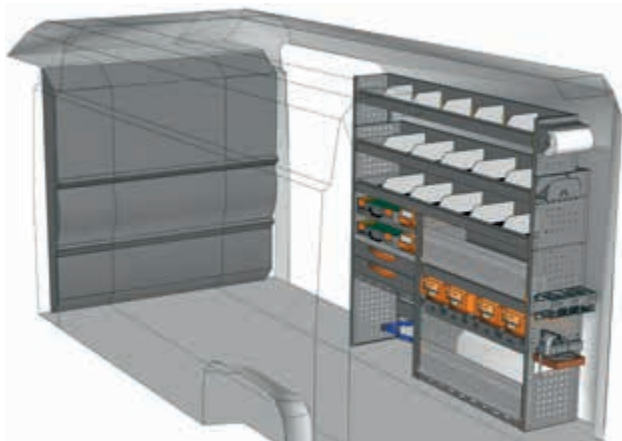
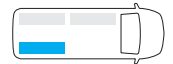

ESEMPIO - EXEMPLE

DU 1717 05\*

L=1733 P=365 H=1700 mm



ESEMPIO - EXEMPLE

DU 1717 07\*

L=1733 P=365 H=1700 mm

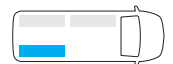

Vista da porta laterale  
Vue de porte latérale



ESEMPIO - EXEMPLE

DU 1717 10\*

L=1733 P=445 H=1700 mm

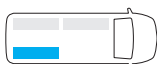

**Non hai trovato il tuo allestimento?**

**Affidati ai nostri professionisti**

Guarda il retro di questo catalogo e  
contatta il punto Store Van piu vicino  
oppure visita il nostro sito.

**Vous n'avez pas trouvé votre  
équipement ? Confiez-vous  
à nos professionnels**

Voir au dos de ce catalogue  
et contactez le point StoreVan  
le plus proche ou visitez notre site web.



\* Kit fissaggio incluso - Jeu de fixation inclus

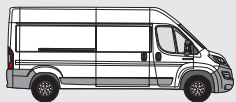

L3 H2

PEUGEOT BOXER  
FURGONE LAMIERATO - FOURGON TÔLE

PROFESSIONAL

# L3 H2 PROFESSIONAL

ESEMPI DI ALLESTIMENTO - EXEMPLES D'AMÉNAGEMENTS

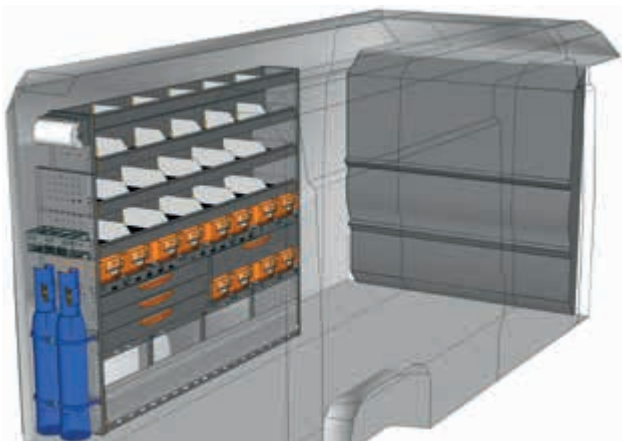

ESEMPIO - EXEMPLE

DU 2017 P1\*

L=2032 P=365 H=1700 mm

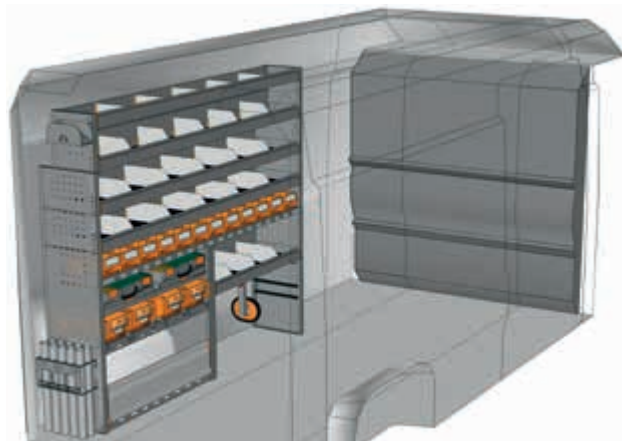
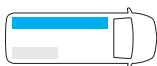

ESEMPIO - EXEMPLE

DU 2017 P2\*

L=2032 P=365 H=1700 mm

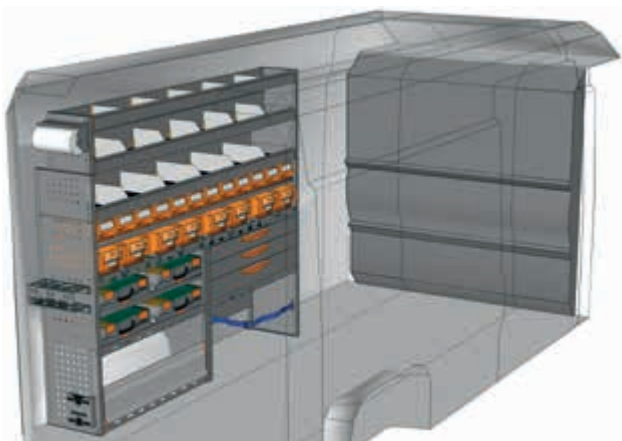
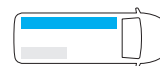

ESEMPIO - EXEMPLE

DU 2017 P3\*

L=2032 P=365 H=1700 mm

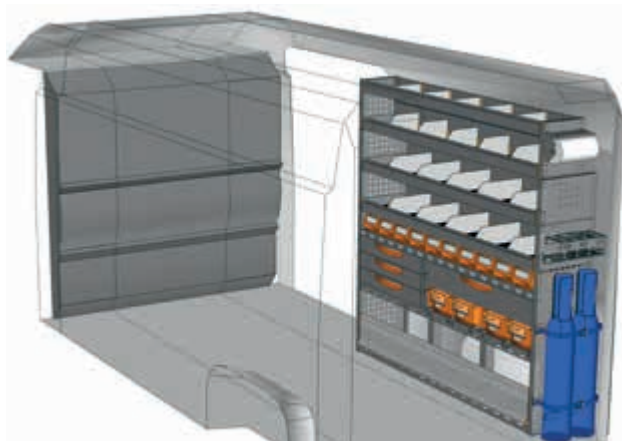
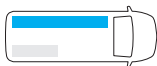

ESEMPIO - EXEMPLE

DU 1717 P1\*

L=1733 P=365 H=1700 mm

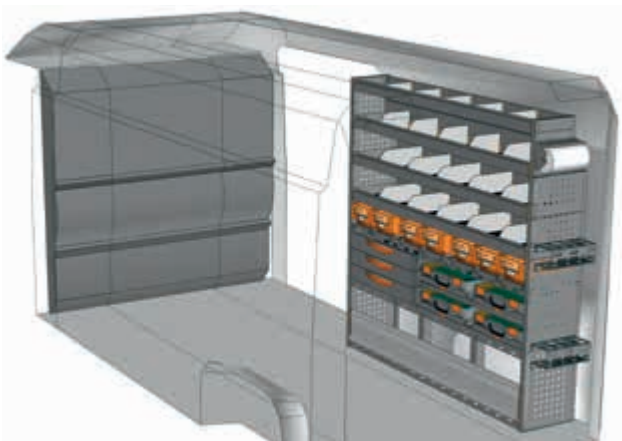
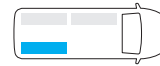

ESEMPIO - EXEMPLE

DU 1717 P2\*

L=1733 P=365 H=1700 mm

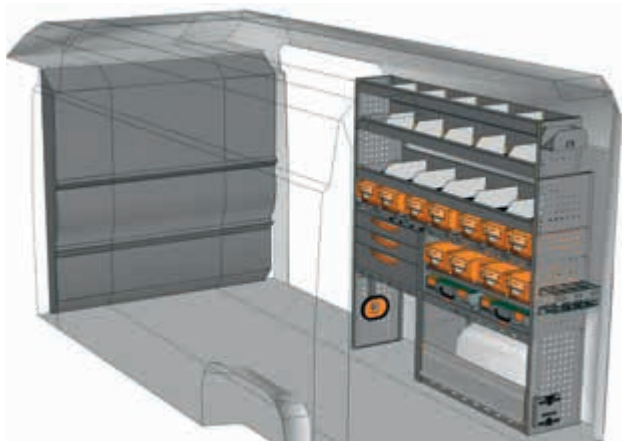

ESEMPIO - EXEMPLE

DU 1717 P3\*

L=1733 P=365 H=1700 mm

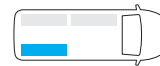

\* Kit fissaggio incluso - Jeu de fixation inclus

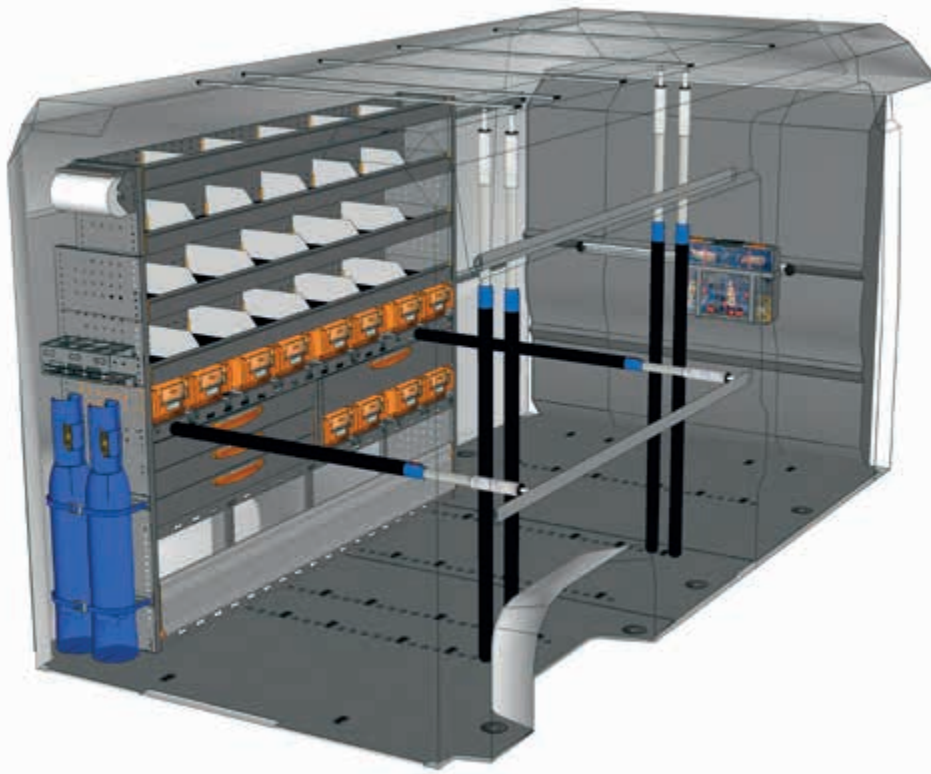
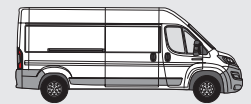

ESEMPIO - EXEMPLE

EXAMPLE DU L4H2 P1\*



- |                         |                          |
|-------------------------|--------------------------|
| 1 x DU 2017 P1          | 10 x F22 FC V22106 00 00 |
| 1 x F22 SF DU30G1 A0 1S | 5 x F22 FC V18025 15 00  |
| 1 x F22 VT V22585 00 08 | 1 x F22 SB BOX080 00 01  |
| 2 x F22 FC V22131 00 00 | 1 x F22 SB CPV080 00 01  |
| 4 x F22 FC V22017 00 00 | 2 x F22 FC V22136 00 00  |
| 2 x F22 FC V18029 15 00 | 2 x F22 FC V22124 00 00  |
| 2 x F22 FC V18029 20 00 | 2 x F22 FC V22148 00 00  |
| 1 x F22 FC V18029 10 00 | 1 x F22 SB YELLOW 63 05  |
|                         | 4 x F22 FC V22582 00 00  |

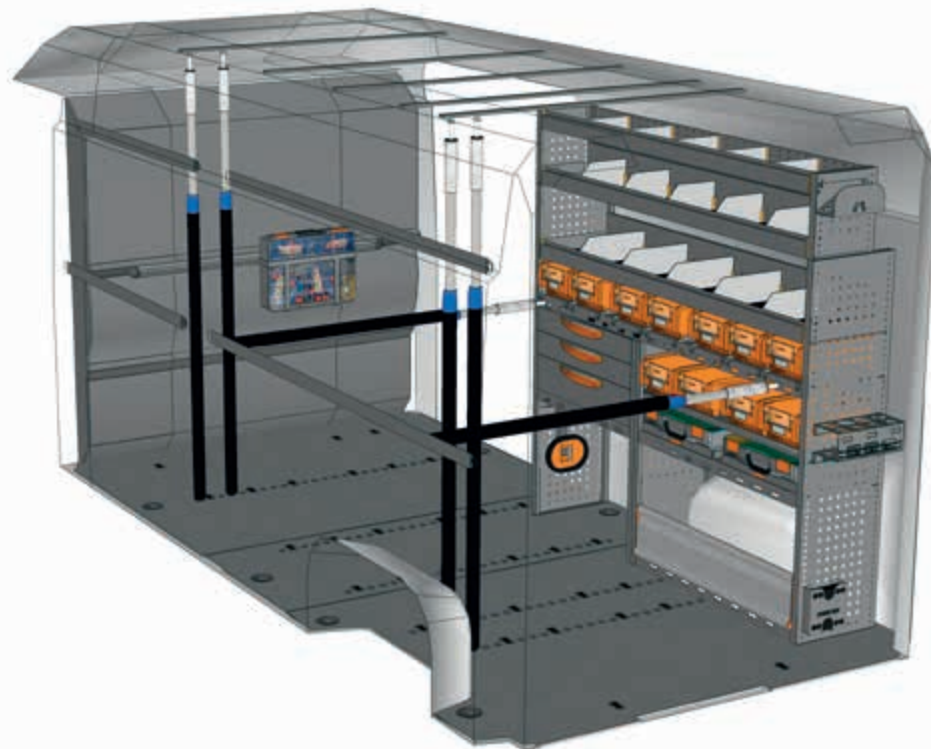

ESEMPIO - EXEMPLE

EXAMPLE DU L4H2 P2\*



- |                         |                          |
|-------------------------|--------------------------|
| 1 x DU 1717 P3          | 10 x F22 FC V22106 00 00 |
| 1 x F22 SF DU30G1 A0 1S | 5 x F22 FC V18025 15 00  |
| 1 x F22 VT V22585 00 08 | 1 x F22 SB BOX080 00 01  |
| 2 x F22 FC V22131 00 00 | 1 x F22 SB CPV080 00 01  |
| 4 x F22 FC V22017 00 00 | 2 x F22 FC V22136 00 00  |
| 2 x F22 FC V18029 15 00 | 2 x F22 FC V22124 00 00  |
| 2 x F22 FC V18029 20 00 | 2 x F22 FC V22148 00 00  |
| 1 x F22 FC V18029 10 00 | 1 x F22 SB YELLOW 63 05  |
|                         | 4 x F22 FC V22582 00 00  |



vedi pag. 12/13  
voir page 12/13

\* Kit fissaggio incluso - Jeu de fixation inclus

**Non hai trovato il tuo allestimento?  
Affidati ai nostri professionisti**

Guarda il retro di questo catalogo e  
contatta il punto Store Van piu vicino  
oppure visita il nostro sito.

**Vous n'avez pas trouvé votre  
équipement ? Confiez-vous  
à nos professionnels**

Voir au dos de ce catalogue  
et contactez le point StoreVan  
le plus proche ou visitez notre site web.



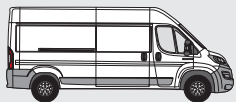

L3 H2

PEUGEOT BOXER  
FURGONE LAMIERATO - FOURGON TÔLÉ

MOBILE

# L3 H2 MOBILE

ESEMPI DI ALLESTIMENTO - EXEMPLES D'AMÉNAGEMENTS

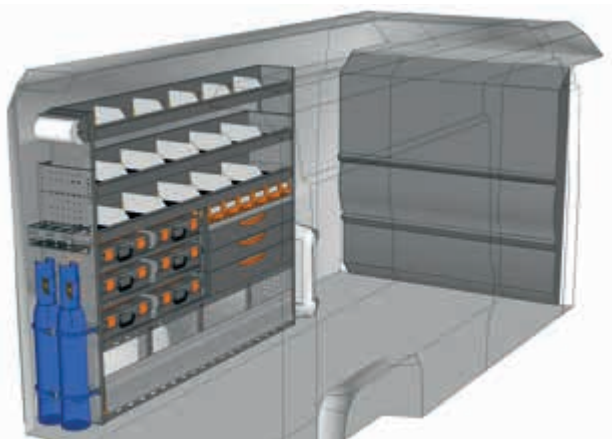

ESEMPIO - EXEMPLE

DU 2017 M1\*

L=2032 P=365 H=1700 mm

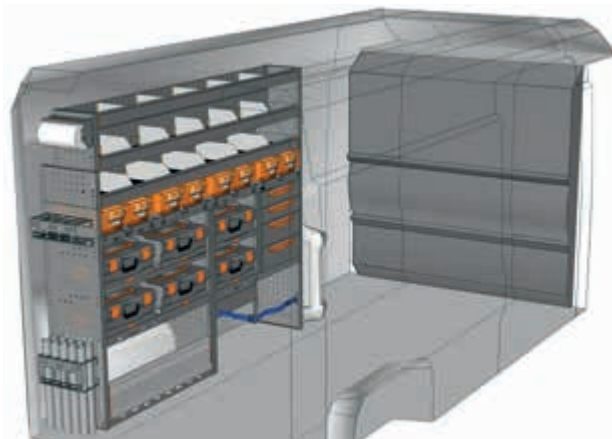
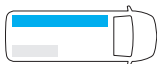

ESEMPIO - EXEMPLE

DU 2017 M2\*

L=2032 P=365 H=1700 mm

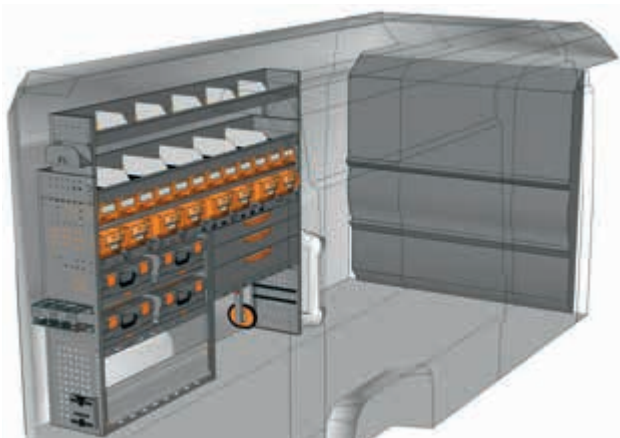
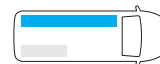

ESEMPIO - EXEMPLE

DU 2017 M3\*

L=2032 P=365 H=1700 mm

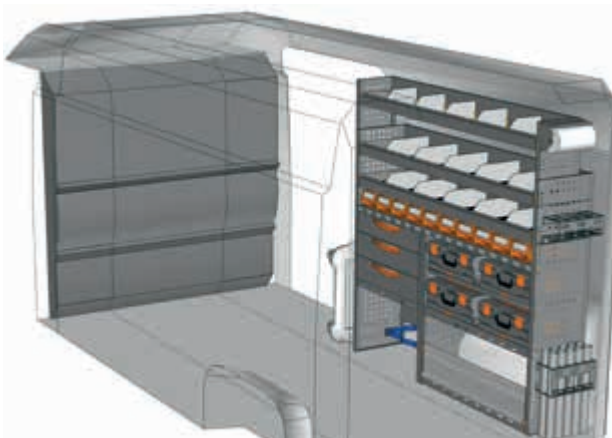
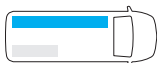

ESEMPIO - EXEMPLE

DU 1717 M1\*

L=1733 P=365 H=1700 mm

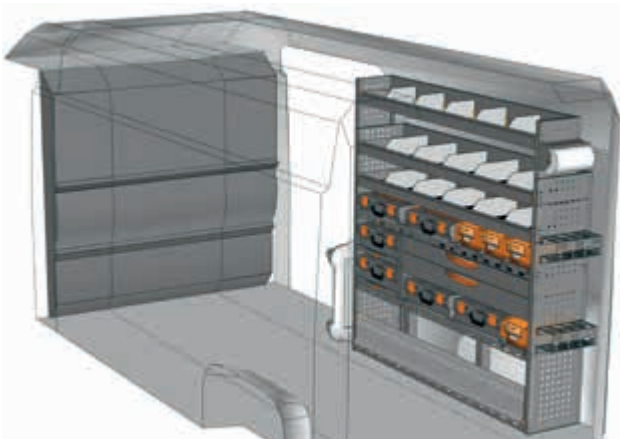

ESEMPIO - EXEMPLE

DU 1717 M2\*

L=1733 P=365 H=1700 mm

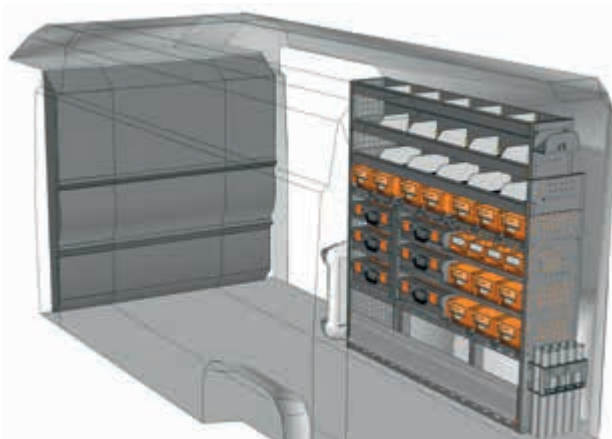
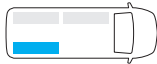

ESEMPIO - EXEMPLE

DU 1717 M3\*

L=1733 P=365 H=1700 mm

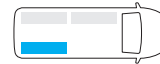

\* Kit fissaggio incluso - Jeu de fixation inclus

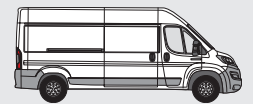

ESEMPI DI ALLESTIMENTO - EXEMPLES D'AMÉNAGEMENTS

**MOBILE** **L3 H2**

FURGONE LAMIERATO - FOURGON TÔLE  
**PEUGEOT BOXER**

**MOBILE**

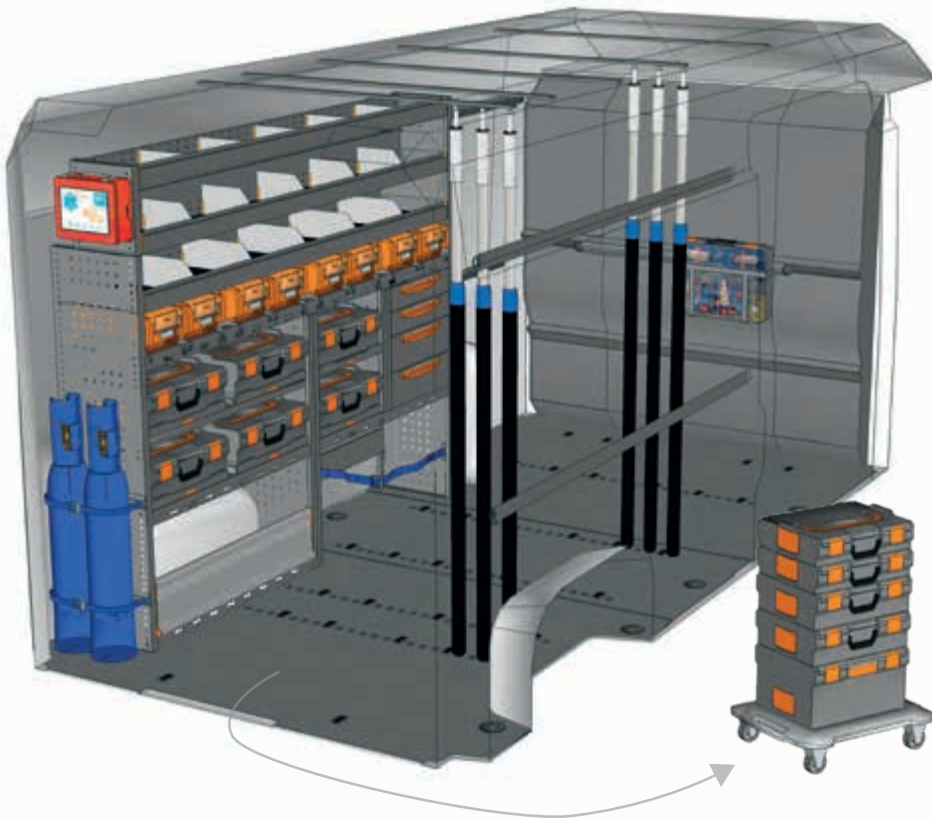

**ESEMPIO - EXEMPLE**

**EXEMPLE DU L4H2 M1\***



- |                          |                         |
|--------------------------|-------------------------|
| 1 x DU 2017 M2           | 5 x F22 FC V18025 15 00 |
| 1 x F22 SF DU30G1 A0 1S  | 1 x F22 SB BOX080 00 01 |
| 1 x F22 VT V22585 00 08  | 1 x F22 SB CPV080 00 01 |
| 6 x F22 FC V22017 00 00  | 2 x F22 FC V22136 00 00 |
| 2 x F22 FC V18029 15 00  | 2 x F22 FC V22124 00 00 |
| 2 x F22 FC V18029 20 00  | 2 x F22 FC V22148 00 00 |
| 1 x F22 FC V18029 10 00  | 1 x F22 SB YELLOW 63 05 |
| 10 x F22 FC V22106 00 00 | 4 x F22 FC V22582 00 00 |

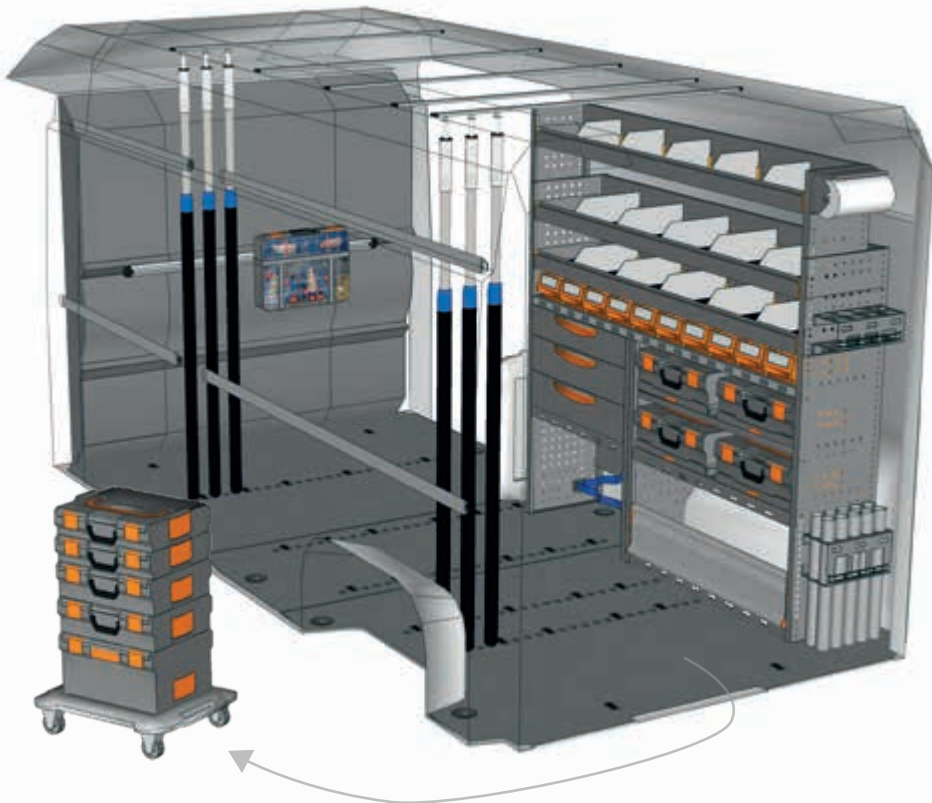

**ESEMPIO - EXEMPLE**

**EXEMPLE DU L4H2 M2\***



- |                          |                         |
|--------------------------|-------------------------|
| 1 x DU 1717 M1           | 5 x F22 FC V18025 15 00 |
| 1 x F22 SF DU30G1 A0 1S  | 1 x F22 SB BOX080 00 01 |
| 1 x F22 VT V22585 00 08  | 1 x F22 SB CPV080 00 01 |
| 6 x F22 FC V22017 00 00  | 2 x F22 FC V22136 00 00 |
| 2 x F22 FC V18029 15 00  | 2 x F22 FC V22124 00 00 |
| 2 x F22 FC V18029 20 00  | 2 x F22 FC V22148 00 00 |
| 1 x F22 FC V18029 10 00  | 1 x F22 SB YELLOW 63 05 |
| 10 x F22 FC V22106 00 00 | 4 x F22 FC V22582 00 00 |



vedi pag. 12/13  
voir page 12/13

\* Kit fissaggio incluso - Jeu de fixation inclus

**Non hai trovato il tuo allestimento?**

**Affidati ai nostri professionisti**

Guarda il retro di questo catalogo e  
contatta il punto Store Van piu vicino  
oppure visita il nostro sito.

**Vous n'avez pas trouvé votre  
équipement ? Confiez-vous  
à nos professionnels**

Voir au dos de ce catalogue  
et contactez le point StoreVan  
le plus proche ou visitez notre site web.



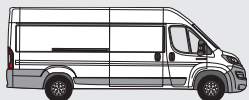

L4 H2

PEUGEOT BOXER  
FURGONE LAMIERATO - FOURGON TÔLÉ

PROFESSIONAL

# L4 H2 PROFESSIONAL

ESEMPI DI ALLESTIMENTO - EXEMPLES D'AMÉNAGEMENTS

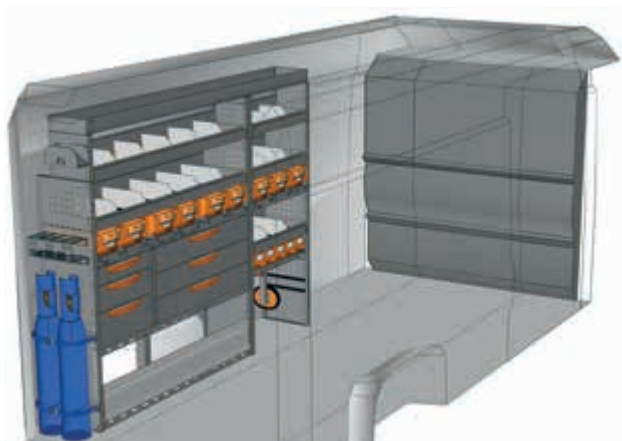

ESEMPIO - EXEMPLE

**DU 2217 P1\***

L=2241 P=365 H=1740 mm

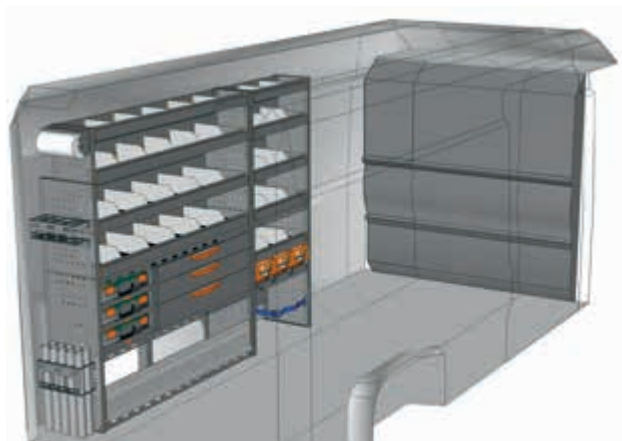
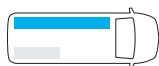

ESEMPIO - EXEMPLE

**DU 2217 P2\***

L=2241 P=365 H=1700 mm

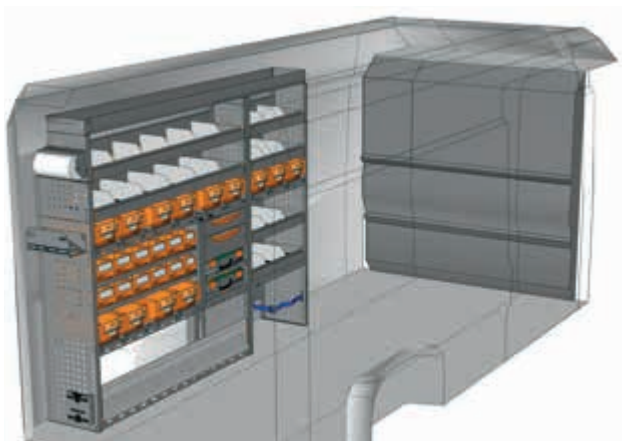
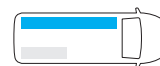

ESEMPIO - EXEMPLE

**DU 2217 P3\***

L=2241 P=365 H=1740 mm

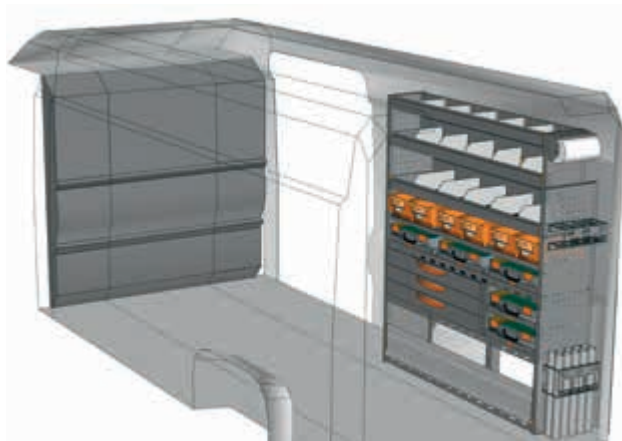

ESEMPIO - EXEMPLE

**DU 1517 P1\***

L=1524 P=365 H=1700 mm

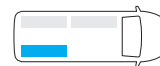

ESEMPIO - EXEMPLE

**DU 1517 P2\***

L=1524 P=365 H=1700 mm

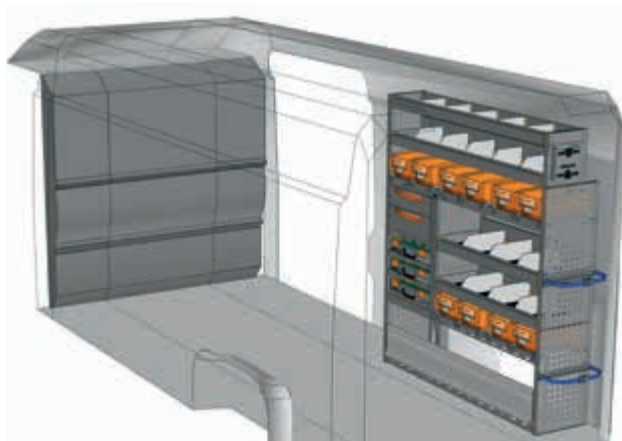
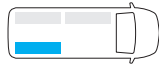

ESEMPIO - EXEMPLE

**DU 1517 P3\***

L=1524 P=365 H=1700 mm

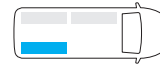

\* Kit fissaggio incluso - Jeu de fixation inclus

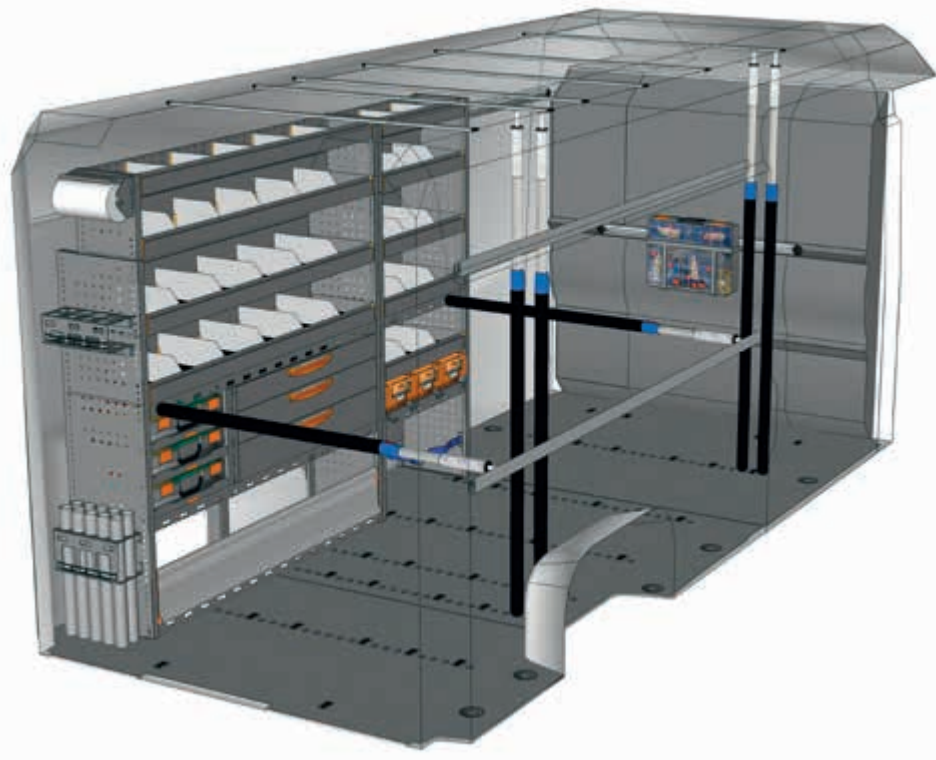
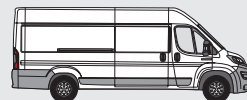

**ESEMPIO - EXEMPLE**

**EXAMPLE DU L5H2 P1\***



- |                         |                          |
|-------------------------|--------------------------|
| 1 x DU 2217 P2          | 10 x F22 FC V22106 00 00 |
| 1 x F22 SF DU3LG1 A0 1S | 6 x F22 FC V18025 15 00  |
| 1 x F22 VT V22585 00 08 | 1 x F22 SB BOX080 00 01  |
| 2 x F22 FC V22131 00 00 | 1 x F22 SB CPV080 00 01  |
| 4 x F22 FC V22017 00 00 | 2 x F22 FC V22136 00 00  |
| 2 x F22 FC V18029 15 00 | 2 x F22 FC V22124 00 00  |
| 2 x F22 FC V18029 25 00 | 2 x F22 FC V22148 00 00  |
| 1 x F22 FC V18029 10 00 | 1 x F22 SB YELLOW 63 05  |
|                         | 4 x F22 FC V22582 00 00  |

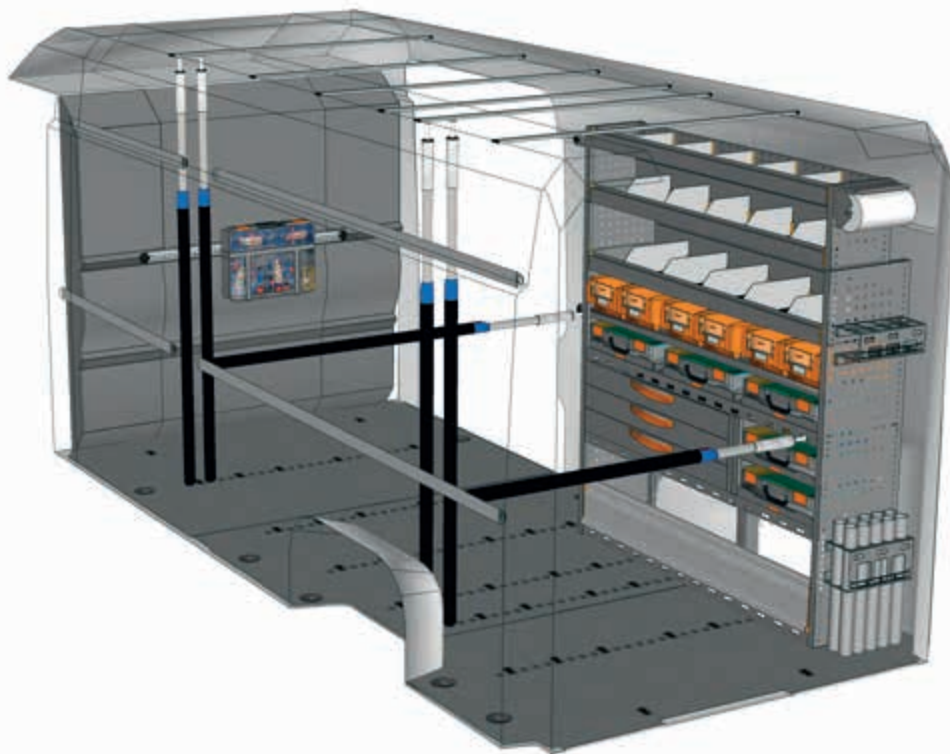

**ESEMPIO - EXEMPLE**

**EXAMPLE DU L5H2 P2\***



- |                         |                          |
|-------------------------|--------------------------|
| 1 x DU 1717 P3          | 2 x F22 FC V18029 10 00  |
| 1 x F22 SF DU3LG1 A0 1S | 14 x F22 FC V22106 00 00 |
| 1 x F22 VT V22585 00 08 | 6 x F22 FC V18025 15 00  |
| 2 x F22 FC V22131 00 00 | 1 x F22 SB BOX080 00 01  |
| 4 x F22 FC V22017 00 00 | 1 x F22 SB CPV080 00 01  |
| 1 x F22 FC V18029 05 00 | 2 x F22 FC V22136 00 00  |
| 2 x F22 FC V18029 15 00 | 2 x F22 FC V22124 00 00  |
| 2 x F22 FC V18029 25 00 | 2 x F22 FC V22148 00 00  |
|                         | 1 x F22 SB YELLOW 63 05  |
|                         | 4 x F22 FC V22582 00 00  |

**Non hai trovato il tuo allestimento?  
Affidati ai nostri professionisti**

Guarda il retro di questo catalogo e  
contatta il punto Store Van piu vicino  
oppure visita il nostro sito.

**Vous n'avez pas trouvé votre  
équipement ? Confiez-vous  
à nos professionnels**

Voir au dos de ce catalogue  
et contactez le point StoreVan  
le plus proche ou visitez notre site web.



vedi pag. 12/13  
voir page 12/13

\* Kit fissaggio incluso - Jeu de fixation inclus

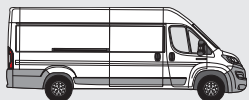

L4 H2

PEUGEOT BOXER  
FURGONE LAMIERATO - FOURGON TÔLÉ

MOBILE

# L4 H2 MOBILE

ESEMPI DI ALLESTIMENTO - EXEMPLES D'AMÉNAGEMENTS

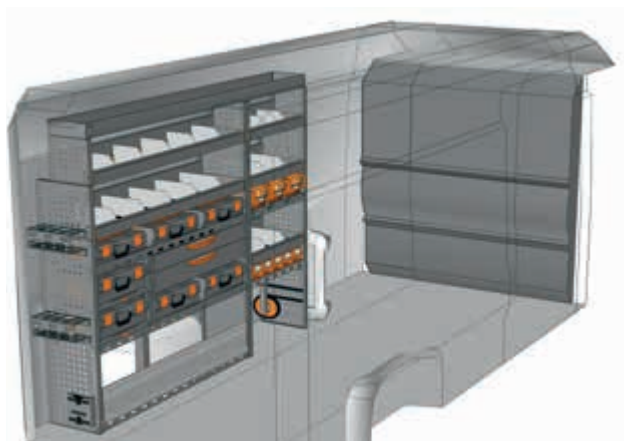

ESEMPIO - EXEMPLE

DU 2217 M1\*

L=2241 P=365 H=1740 mm

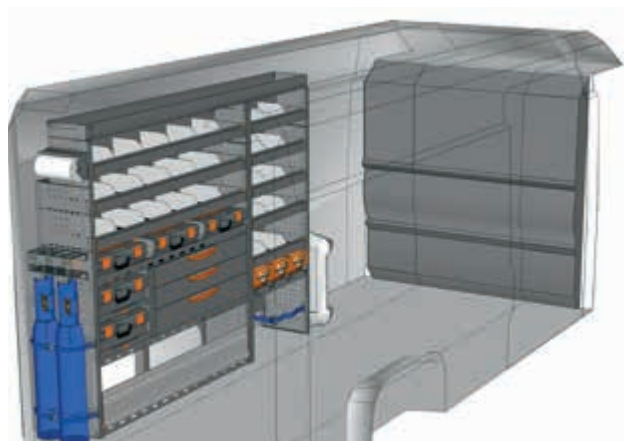
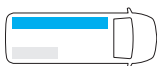

ESEMPIO - EXEMPLE

DU 2217 M2\*

L=2241 P=365 H=1740 mm

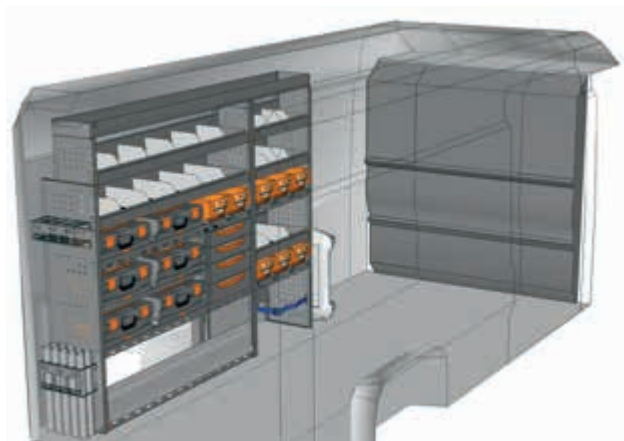
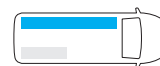

ESEMPIO - EXEMPLE

DU 2217 M3\*

L=2241 P=365 H=1740 mm

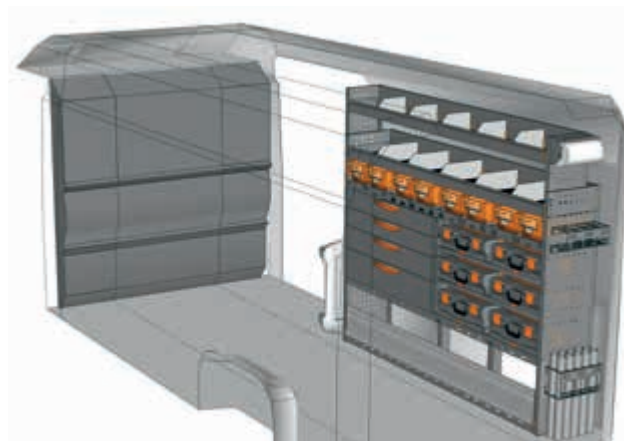
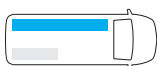

ESEMPIO - EXEMPLE

DU 2017 M4\*

L=2032 P=365 H=1700 mm

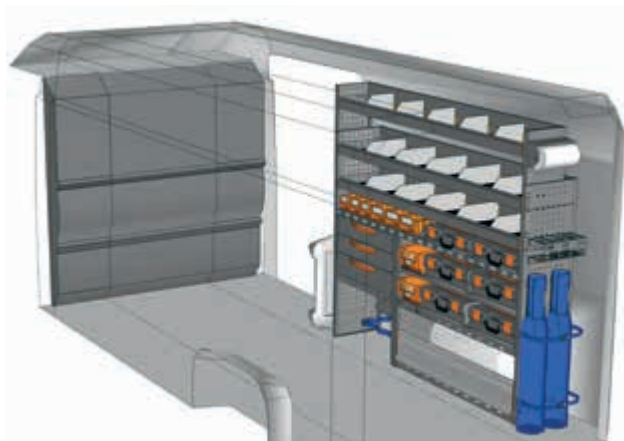
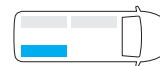

ESEMPIO - EXEMPLE

DU 1917 M5\*

L=1942 P=365 H=1700 mm

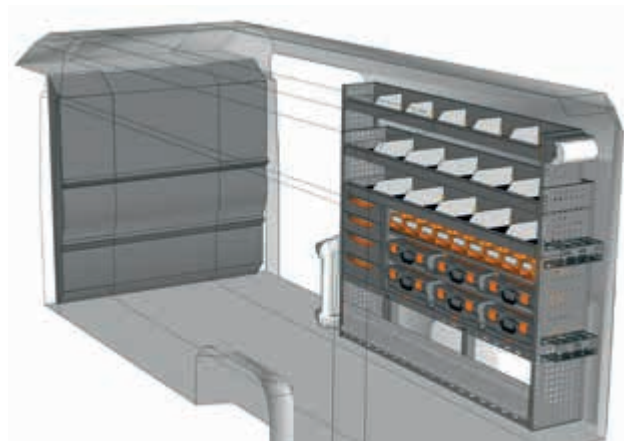
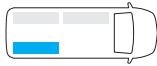

ESEMPIO - EXEMPLE

DU 2017 M6\*

L=2032 P=365 H=1700 mm

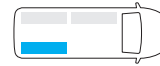

\* Kit fissaggio incluso - Jeu de fixation inclus



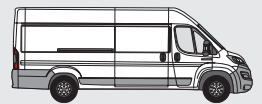

ESEMPI DI ALLESTIMENTO - EXEMPLES D'AMÉNAGEMENTS

MOBILE

L4 H2

FURGONE LAMIERATO - FOURGON TÔLE

MOBILE

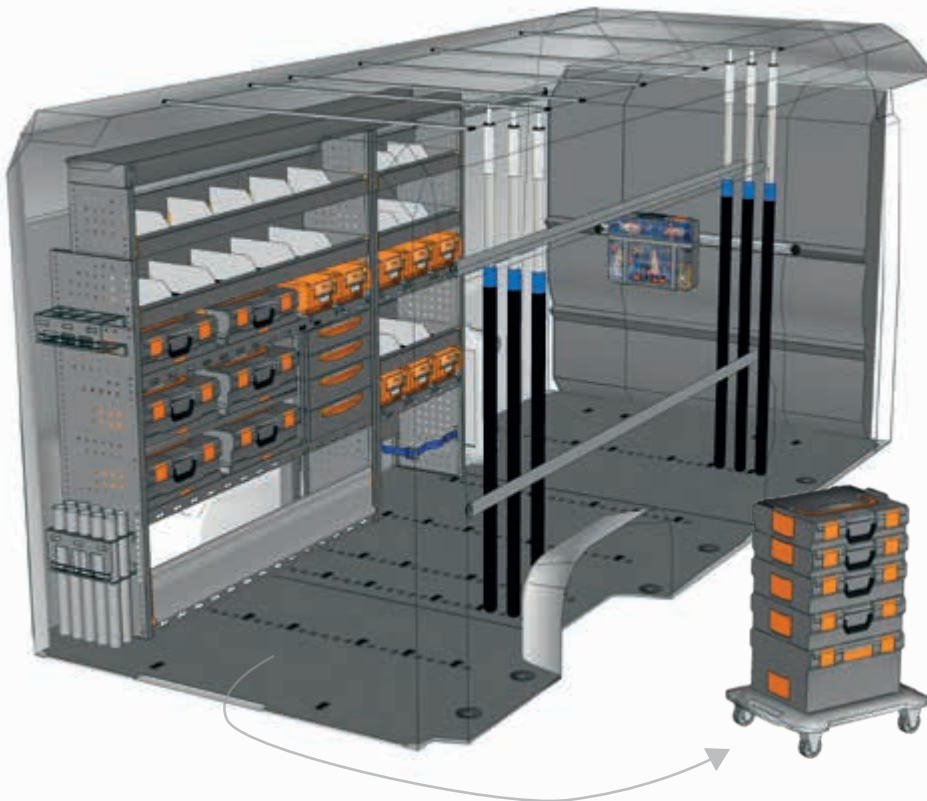

ESEMPIO - EXEMPLE

EXEMPLE DU L5H2 M1\*



- |                          |                         |
|--------------------------|-------------------------|
| 1 x DU 2217 M3           | 6 x F22 FC V18025 15 00 |
| 1 x F22 SF DU3LG1 A0 1S  | 1 x F22 SB BOX080 00 01 |
| 1 x F22 VT V22585 00 08  | 1 x F22 SB CPV080 00 01 |
| 6 x F22 FC V22017 00 00  | 2 x F22 FC V22136 00 00 |
| 2 x F22 FC V18029 15 00  | 2 x F22 FC V22124 00 00 |
| 2 x F22 FC V18029 25 00  | 2 x F22 FC V22148 00 00 |
| 1 x F22 FC V18029 10 00  | 1 x F22 SB YELLOW 63 05 |
| 10 x F22 FC V22106 00 00 | 4 x F22 FC V22582 00 00 |

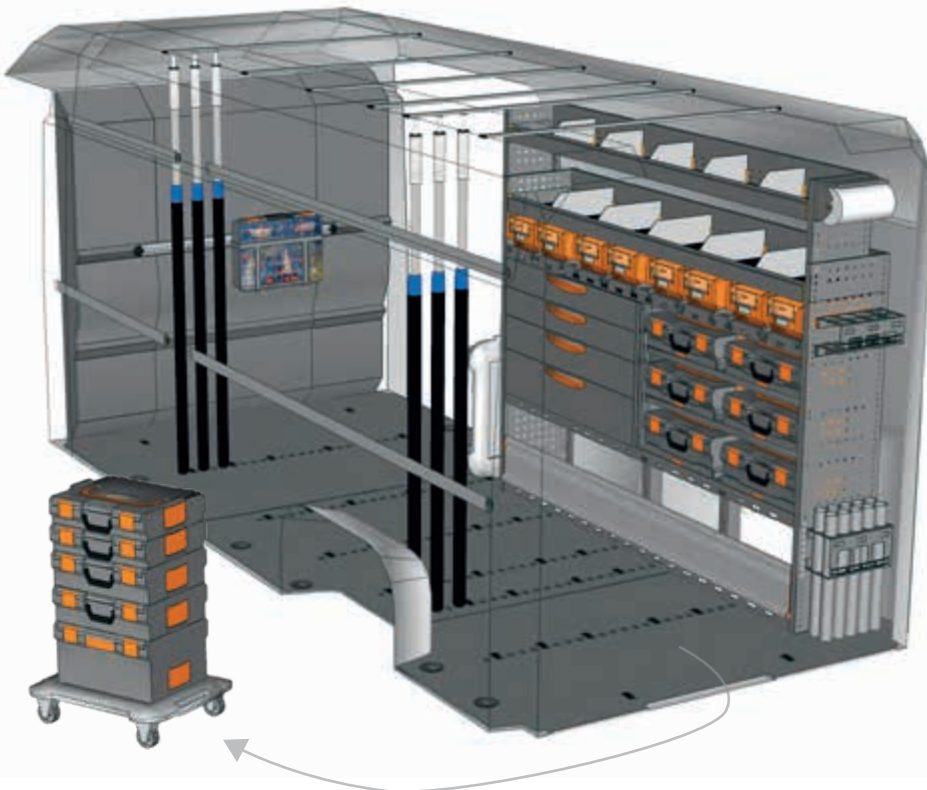

ESEMPIO - EXEMPLE

EXEMPLE DU L5H2 M2\*



- |                          |                         |
|--------------------------|-------------------------|
| 1 x DU 2017 M4           | 6 x F22 FC V18025 15 00 |
| 1 x F22 SF DU3LG1 A0 1S  | 1 x F22 SB BOX080 00 01 |
| 1 x F22 VT V22585 00 08  | 1 x F22 SB CPV080 00 01 |
| 6 x F22 FC V22017 00 00  | 2 x F22 FC V22136 00 00 |
| 2 x F22 FC V18029 15 00  | 2 x F22 FC V22124 00 00 |
| 2 x F22 FC V18029 25 00  | 2 x F22 FC V22148 00 00 |
| 1 x F22 FC V18029 10 00  | 1 x F22 SB YELLOW 63 05 |
| 10 x F22 FC V22106 00 00 | 4 x F22 FC V22582 00 00 |



vedi pag. 12/13  
voir page 12/13

\* Kit fissaggio incluso - Jeu de fixation inclus

**Non hai trovato il tuo allestimento?**

**Affidati ai nostri professionisti**

Guarda il retro di questo catalogo e  
contatta il punto Store Van piu vicino  
oppure visita il nostro sito.

**Vous n'avez pas trouvé votre  
équipement ? Confiez-vous  
à nos professionnels**

Voir au dos de ce catalogue  
et contactez le point StoreVan  
le plus proche ou visitez notre site web.





VEICOLO VÉHICULE	BARRE PORTATUTTO BARRES PORTE-TOUT	DIMENSIONI DIMENSIONS	PESO POIDS	PORTATA CHARGE
	ART.			
Modello - Modèle L1 H1	<b>F22 KK DU10H1 B1 00</b>	2180X1760 mm	11,50 kg	138,50 kg
Modello - Modèle L1 H2	<b>F22 KK DU10H2 B1 00</b>	2170X1660 mm	11,00 kg	139,00 kg
Modello - Modèle L2 H1	<b>F22 KK DU20H1 B1 00</b>	2700X1760 mm	12,00 kg	138,00 kg
Modello - Modèle L2 H2	<b>F22 KK DU20H2 B1 00</b>	2650X1660 mm	11,00 kg	139,00 kg
Modello - Modèle L3 H2	<b>F22 KK DU30H2 B1 00</b>	3200X1660 mm	14,50 kg	135,50 kg
Modello - Modèle L4 H2	<b>F22 KK DU3LH2 B1 00</b>	3600X1660 mm	18,50 kg	131,50 kg

- Solo per veicolo con porte posteriori a battente.
- Seulement pour véhicule avec portes arrière battantes.

**BARRE PORTATUTTO - BARRES PORTE TOUT**

- Barre Portatutto complete di:
  - barre in alluminio complete di attacchi e profilo in gomma
  - viterie di fissaggio fornite in acciaio inox
- Barres Porte-Tout complètes de :
  - barres en aluminium avec fixations et profil en caoutchouc
  - visserie de fixation fournie en acier inox



VEICOLO VÉHICULE	PORTATUTTO PORTE-TOUT	DIMENSIONI DIMENSIONS	PESO POIDS	PORTATA CHARGE
	ART.			
Modello - Modèle L1 H1	<b>F22 KK DU10H1 R1 00</b>	3000X1800 mm	26,50 kg	123,50 kg
Modello - Modèle L1 H2	<b>F22 KK DU10H2 R1 00</b>	3000X1700 mm	26,00 kg	124,00 kg
Modello - Modèle L2 H1	<b>F22 KK DU20H1 R1 00</b>	3400X1800 mm	28,50 kg	121,50 kg
Modello - Modèle L2 H2	<b>F22 KK DU20H2 R1 00</b>	3400X1700 mm	27,00 kg	123,00 kg
Modello - Modèle L3 H2	<b>F22 KK DU30H2 R1 00</b>	3700X1700 mm	31,00 kg	119,00 kg
Modello - Modèle L4 H2	<b>F22 KK DU3LH2 R1 00</b>	4000X1700 mm	33,00 kg	117,00 kg

- Solo per veicolo con porte posteriori a battente.
- Seulement pour véhicule avec portes arrière battantes.

**PORTATUTTO - PORTE TOUT**

- Portatutto completo di:
  - barre in alluminio complete di attacchi e profilo in gomma
  - sponde laterali in alluminio
  - rullo di caricamento in alluminio
  - viterie di fissaggio fornite in acciaio inox
- Porte-Tout complet de :
  - barres en aluminium avec fixations et profil en caoutchouc
  - rebords latéraux en aluminium
  - rouleau de chargement en aluminium
  - visserie de fixation fournie en acier inox

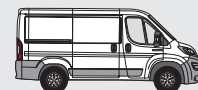

- Coppia tappi
- Paire bouchons

ART. **F22 UP 070010 00 07**



- Coppia alette light finali
- Paire ailettes light d'extrémité

ART. **F22 UP 070040 00 07**  
73x100 mm H



- Coppia alette strong finali
- Paire ailettes strong d'extrémité

ART. **F22 UP 070050 00 07**  
60x53x200 mm H



- Aletta light centrale destra
- Ailette light centrale droite

ART. **F22 UP 070060 00 07**  
133x53x64 mm H



- Aletta light centrale sinistra
- Ailette light centrale gauche

ART. **F22 UP 070070 00 07**  
133x53x64 mm H



- Coppia fermi
- Paire arrêtoirs

ART. **F22 UP 070100 00 07**  
70x33x90 mm H



- Fermo abbattibile light
- Arrêtoir rabattable light

ART. **F22 UP 070080 00 ZZ**



- Fermo abbattibile strong
- Arrêtoir rabattable strong

ART. **F22 UP 070090 00 ZZ**



- Kit supporto lampeggiante\*
- Kit support clignotant\*

ART. **F22 UP 070170 00 07**  
200x161 mm



- Kit fissaggio rullo
- Kit fixation rouleau

ART. **F22 UP 070180 00 ZZ**



- Cinghia autobloccante
- Sangle autobloquante

ART. **F22 CMV 23575 00 00**  
1000x25 mm H  
**F22 CMV 97020 00 00**  
1200x35 mm H



- Porta tubi in acciaio inox
- Porte-tubes en acier inox

ART. **F22 PA 07A211 00 ZZ**  
2110 mm - Ø 160 mm  
**F22 PA 07A324 00 ZZ**  
3240 mm - Ø 160 mm

\* Lampeggiante escluso  
\* Clignotant exclu



- Porta tubi in PVC stabilizzato
- Porte-tubes en PVC stabilisé

ART. **F22 UP 070200 00 2V**  
2115 mm - Ø 160 mm  
**F22 UP 070210 00 2V**  
2115 mm - Ø 200 mm  
**F22 UP 070220 00 2V**  
3050 mm - Ø 160 mm  
**F22 UP 070230 00 2V**  
3050 mm - Ø 200 mm



- Rinforzo per barra
- Renfort pour barre

ART. **F22 UP 070110 00 ZZ**  
1160 mm  
**F22 UP 070120 00 ZZ**  
1360 mm  
**F22 UP 070130 00 ZZ**  
1460 mm  
**F22 UP 070140 00 ZZ**  
1560 mm  
**F22 UP 070150 00 ZZ**  
1660 mm  
**F22 UP 070160 00 ZZ**  
1760 mm

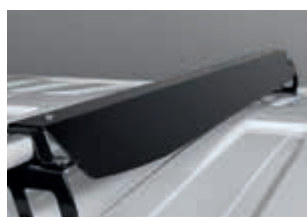

- Spoiler
- Aileron

ART. **F22 UP 050850 00 07**  
850 mm  
**F22 UP 050950 00 07**  
950 mm  
**F22 UP 051100 00 07**  
1100 mm



VEICOLO VÉHICULE	PORTASCALE PORTE-ÉCHELLE	DIMENSIONI DIMENSIONS	PESO POIDS	PORTATA CHARGE
	ART.			
Modello - Modèle L1 H1	<b>F22 KK DU10H1 L1 00</b>	3150X1780 mm	55,50 kg	94,50 kg
Modello - Modèle L1 H2	<b>F22 KK DU10H2 L1 00</b>	3150X1680 mm	55,00 kg	95,00 kg
Modello - Modèle L2 H1	<b>F22 KK DU20H1 L1 00</b>	3550X1780 mm	61,00 kg	89,00 kg
Modello - Modèle L2 H2	<b>F22 KK DU20H2 L1 00</b>	3550X1680 mm	59,00 kg	91,00 kg
Modello - Modèle L3 H2	<b>F22 KK DU30H2 L1 00</b>	3850X1680 mm	65,50 kg	84,50 kg
Modello - Modèle L4 H2	<b>F22 KK DU3LH2 L1 00</b>	4150X1680 mm	70,00 kg	80,00 kg

- Solo per veicolo con porte posteriori a battente. La slitta portascala può essere montata a destra o a sinistra.
- Seulement pour véhicule avec portes arrière battantes. Le chariot porte-échelles peut être monté à droite ou à gauche.

**PORTASCALE - PORTE-ÉCHELLE**

- Portascala completo di:
  - barre in alluminio complete di attacchi e profilo in gomma
  - sponda laterale in alluminio
  - rullo di caricamento in alluminio
  - slitta portascala in alluminio e acciaio inox
  - viterie di fissaggio fornite in acciaio inox
- Porte-échelles complet de :
  - barres en aluminium avec fixations et profil en caoutchouc
  - rebord latéral en aluminium
  - rouleau de chargement en aluminium
  - chariot porte-échelles en aluminium et acier inox
  - visserie de fixation fournie en acier inox



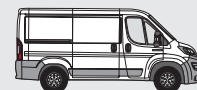

Il montaggio è escluso  
Le montage est exclu

\*\* Adattabile a tutte le lunghezze della sponda  
\*\* Adaptable à toutes les longueurs de ridelle



- Kit radiocomando MAX 10A e telecomando per luce LED
- Kit radiocommande MAX 10A et télécommande pour lumière LED

ART. **F22 UP 070510 00 00**

- Kit radiocomando MAX 24A e telecomando per luce LED
- Kit radiocommande MAX 24A et télécommande pour lumière LED

ART. **F22 UP 070520 00 00**



- Strip LED con doppio cavo
- Ruban LED avec câble double

ART. **F22 UP 070530 00 13**  
Luce arancio  
Lumière orange  
4100 mm\*\*

ART. **F22 UP 070530 00 13**  
Luce bianca  
Lumière blanche  
4100 mm\*\*

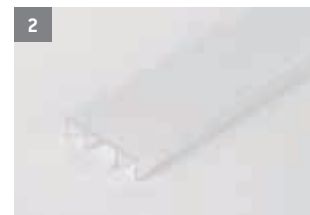

- Profilo in policarbonato opalino diffondente per luce LED
- Profilé en polycarbonate opalin diffusant pour lumière LED

ART. **F22 UP 070410 00 00**  
3000 mm\*\*

ART. **F22 UP 070420 00 00**  
4700 mm\*\*



- Archetto fisso ferma scala
- Arceau fixe de blocage d'échelle

ART. **F22 UP 070300 00 07**



- Archetto abbattibile ferma scala
- Arceau rabattable de blocage d'échelle

ART. **F22 UP 070310 00 07**

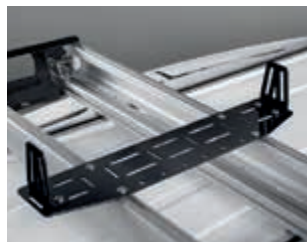

- Piastra universale di fissaggio
- Plaque universelle de fixation

ART. **F22 UP 070320 00 07**



- Prolunga
- Rallonge

ART. **F22 UP 070330 00 07**



- Kit molle a gas
- Kit ressorts à gaz

ART. **F22 UP 070340 00 00**  
30 daN

ART. **F22 UP 070350 00 00**  
70 daN

ART. **F22 KT PAP265 00 01**

- Kit porta rotolo con carta Ø 130 mm
- Set support avec rouleau de papier Ø 130 mm

ART. **F22 KT CAB220 00 01**

- Sella reggicavi
- Support pour câbles

ART. **F22 KT SPR365 00 01**

- Porta bombolette P=365 mm
- Porte bombes aérosol P=365 mm

ART. **F22 KT PAP365 00 01**

- Kit porta rotolo con carta Ø 240 mm
- Set support avec rouleau de papier Ø 240 mm

ART. **F22 KT CAB296 00 01**

- Kit sella reggicavi
- Jeu support pour câbles

ART. **F22 KT SIL296 00 01**

- Kit porta silicone - bombolette
- Set porte silicon - bombes aérosols

ART. **F22 KT AID265 00 01**

- Kit pronto soccorso
- Trousse de premier secours

ART. **F22 KT DOC365 00 01**

- Tasca porta documenti A4 - 362x68x209 mm H
- Pochette porte documents A4 - 362x68x209 mm H

ART. **F22 KT SPR160 00 01**

- Kit porta bombolette (2 posti)
- Set port-aérosol a 2 place

ART. **F22 KT WAS000 00 00**

- Contenitore salviette lavamani
- Bac d'essuie mains

ART. **F22 KT REC365 00 01**

- Kit porta contenitore
- Jeu porte bac d'essuie mains

ART. **F22 KT WAS365 00 01**

- Kit lavamani
- Set lavage des mains

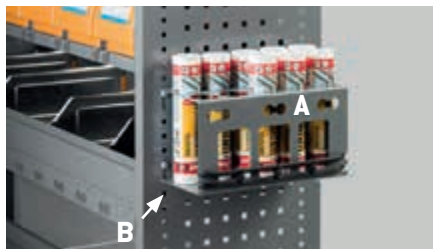
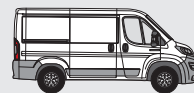

Kit porta silicone  
Set porte silicon

A + B

ART. **F22 KT BAR296 00 01** A

- Supporto porta barre filettate / silicone
- Support porte-barres filetées / silicon

ART. **F22 KT BAR296 02 01** B

- Adattatore per cartucce silicone
- Adaptateur pour cartouches silicone



Kit porta barre filettate  
Jeu porte-barres filetées

A + B

ART. **F22 KT BAR296 00 01** A

- Supporto porta barre filettate / silicone
- Support porte-barres filetées / silicon

ART. **F22 KT BAR296 01 01** B

- 5 tubi per supporto porta barre filettate
- 5 tuyaux pour porte-barres filetées

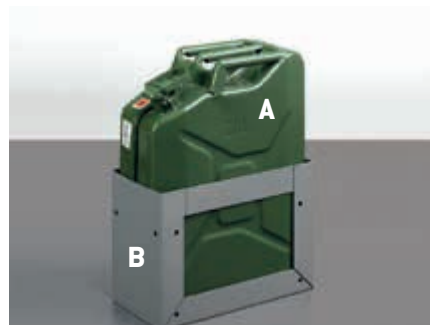

ART. **F22 KT OIL20L 00 00** A

- Tanica in ferro capacità 20 LT
- Bidon en fer 20 LT

ART. **F22 KT OIL365 00 01** B

- Porta tanica
- Porte - bidon

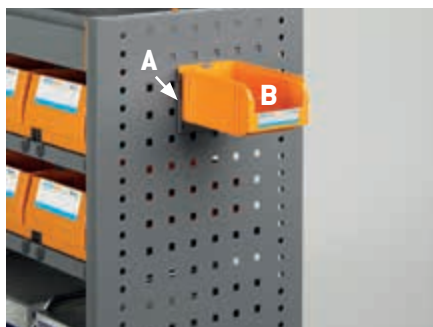

ART. **F22 FA BL7433 00 01** A

- Barra aggancio per 1 contenitore misura 1PL
- Barre porte bac pour 1 bac mesure 1PL

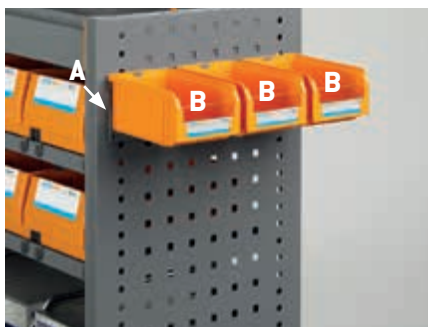

ART. **F22 FA BL7434 00 01** A

- Barra aggancio per 3 contenitori misura 1PL
- Barre porte bac pour 3 bacs mesure 1PL

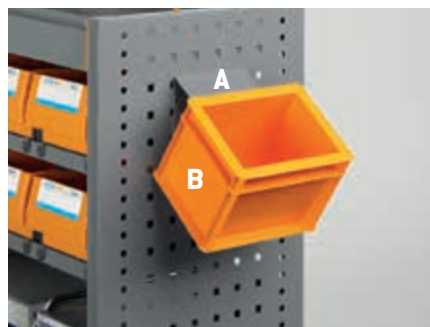

ART. **F22 FA BL7432 00 01** A

- Barra aggancio per 1 contenitore Euro Box
- Barre porte bac pour 1 bac Euro Box

ART. **F22 FA PM1751 00 25** B

- Contenitore in polipropilene misura 1PL
- Bac en polypropylène mesure 1PL

ART. **F22 FA PM1751 00 25** B

- Contenitore in polipropilene misura 1PL
- Bac en polypropylène mesure 1PL

ART. **F22 FA PA2251 A0 25** B

- Cassetta in polipropilene serie Euro Box
- Caisse en polypropylène série Euro Box



ART. **F22 KT MAG020 00 00**

- Kit 10 calamite Ø 20 mm
- Set de 10 aimants Ø 20mm



ART. **F22 KT RUB160 00 01**

- Tasca porta tappetini - 158x50x171 mm H
- Poche métallique port-tapis antidérapantes - 158x50x171 mm H

ART. **F22 KT MAG025 00 00**

- Kit 10 calamite Ø 25 mm
- Set de 10 aimants Ø 25mm

ART. **F22 KT RUB000 00 07**

- Set 6 tappetini antiscivolo - 150x150x3 mm H
- Set des 6 tapis antidérapantes - 150x150x3 mm H



**ESEMPIO DI UTILIZZO TAPPETINI ANTISCIVOLO**

I tappetini antiscivolo sono usati per aumentare il coefficiente di attrito fino a  $\mu D$  0.6 secondo il principio di calcolo DIN EN 12195-1; 2004 e VDI 2700 ff. Procedura di misurazione secondo la direttiva "VDI 2700 - 15".

**EXEMPLE D'UTILISATION POUR TAPIS ANTIDÉRAPANTES**

Les tapis antidérapants sont utilisés pour augmenter le coefficient de frottement jusqu'à  $\mu D$  0.6 selon le principe de calcul DIN EN 12195-1; 2004 et VDI 2700 ss. Procédure de mesure selon la directive "VDI 2700 - 15".

ART. **F22 KT VAL365 00 01**

- Kit porta valigetta Box 080
- Jeu porte mallette Box 080

ART. **F22 KT ORG000 00 39**

- Organizer porta documenti da sedile
- Organisateur porte-documents pour siege

ART. **F22 WW MOBILE 10 00**

- Tavolo con gambe pieghevoli Work Wood - 980x423x802 mm H
- Table avec pieds Pliables - 980x423x802 mm H

ART. **F22 KT DIS000 00 01**

- Porta dispenser reversibile
- Support réversible pour distributeur de gel

ART. **F22 KT GLV000 00 01**

- Porta guanti monouso
- Distributeur gants jetables

ART. **F22 KT LED001 00 00**

- Lampada a led IP20 12V L=600 mm
- Lampe à led IP20 12V L=600 mm

ART. **F22 SB 00ROLL SU 01** **A**

- Kit supporti per STORE BOX ROLL
- Kit de supports pour STORE BOX ROLL

ART. **F22 SB 00ROLL 00 08** **B**

- Carrello con ruote con freni per valigetta BOX 102-136-238-374
- Plateau roulant à frein pour mallette BOX 102-136-238-374





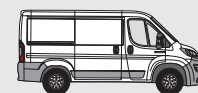

ART. **F22 KT FIR000 00 01** A

- Kit porta bombole
- Set support pour bouteilles de gaz



ART. **F22 FC V18029 03 00** A

- Barra orizzontale fermacarico attacco foro medium L=365 mm
- Barre horizontale d'arrimage fixations trou medium L=365 mm



ART. **F22 FC V18029 03 00** A

- Barra orizzontale fermacarico attacco foro medium L=365 mm
- Barre horizontale d'arrimage fixations trou medium L=365 mm

ART. **F22 KT FIR4KG 00 00** B

- Estintore polvere 4 KG
- Extincteur (poudre) 4 KG

ART. **F22 FC V18029 04 00** A

- Barra orizzontale fermacarico attacco foro medium L=445 mm
- Barre horizontale d'arrimage fixations trou medium L=445 mm

ART. **F22 FC V18029 04 00** A

- Barra orizzontale fermacarico attacco foro medium L=445 mm
- Barre horizontale d'arrimage fixations trou medium L=445 mm

ART. **F22 FC V22868 00 00** B

- Cinghia fermacarico con cricchetto attacco innesto medium
- Sangle d'arrimage à cliquet pour fixations medium

ART. **F22 FC V22869 00 00** B

- Cinghia fermacarico con morsetto attacco innesto medium
- Sangle d'arrimage avec serrage pour fixations medium

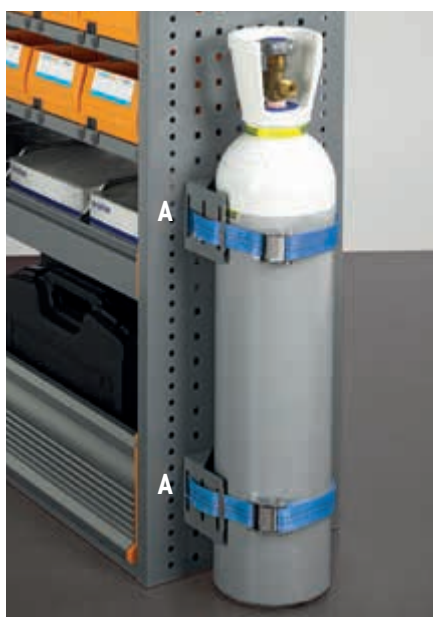

Esempio con  
2 ART. F22 KT FIR000 00 01  
Exemple avec  
2 ART. F22 KT FIR000 00 01

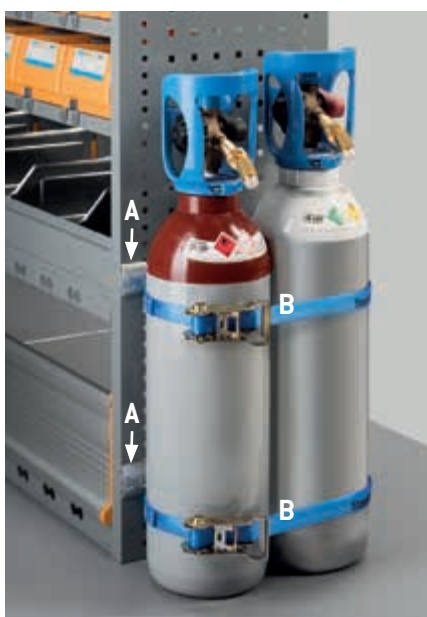

Esempio con  
2 ART. F22 FC V18029 03 00  
2 ART. F22 FC V22868 00 00  
Exemple avec  
2 ART. F22 FC V18029 03 00  
2 ART. F22 FC V22868 00 00

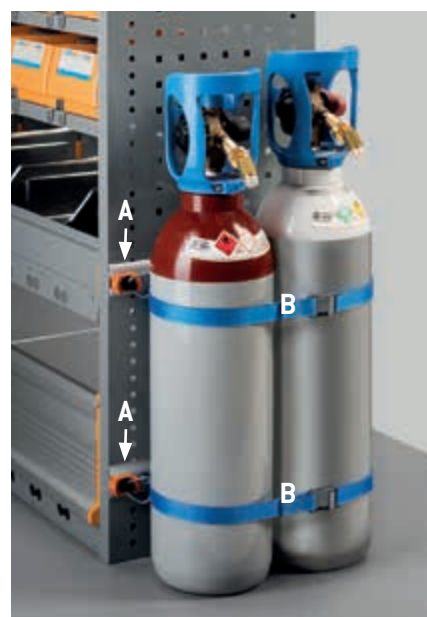

Esempio con  
2 ART. F22 FC V18029 03 00  
2 ART. F22 FC V22869 00 00  
Exemple avec  
2 ART. F22 FC V18029 03 00  
2 ART. F22 FC V22869 00 00

**PEUGEOT BOXER**

FURGONE LAMIERATO - FOURGON TÔLÉ





FURGONE LAMERATO - FOURGON TÔLE  
**PEUGEOT BOXER**

# PEUGEOT BOXER

## CONDIZIONI DI FORNITURA

- Pianali e pannellature forniti in più pezzi.
- Portatutto e portascale vengono forniti **smontati**.
- I moduli vengono forniti **preassemblati** completi del materiale di ancoraggio al veicolo.
- Per l'installazione dei prodotti si consiglia di rivolgersi alla nostra rete di **installatori autorizzati**.
- I prodotti vengono forniti completi di **imballo**.
- **5 anni di garanzia** sui nostri prodotti.
- Le portate si riferiscono a **peso uniformemente distribuito**.



## CONDITIONS DE FOURNITURE

- Planchers et habillages fournis en plusieurs éléments.
- Galeries de toit et porte-échelles sont fournis **démontés**.
- Les modules sont fournis **pré-montés**, avec le matériel de fixation au véhicule.
- Pour l'installation des produits, il est conseillé de s'adresser à notre réseau d' **installateurs agréés**.
- Les produits sont fournis **emballés**.
- **5 ans de garantie** sur nos produits.
- Les capacités de charge se réfèrent à **charge uniformément répartie**.



FAMI S.R.L.

VIA STAZIONE ROSSANO, 13 – 36027 ROSÀ (VI) ITALY  
TEL +39 0424 585455 R.A. – FAX +39 0424 585482  
INFO@FAMISPA.COM – WWW.FAMISPA.COM

INFO@STOREVAN.COM – WWW.STOREVAN.COM

